



A NEW LEGACY

JULY 16

SEE IT **IN THEATERS** | **AND ON HBO MAX**
ONLY AVAILABLE ON THE AD-FREE PLAN

ACTIVITY BOOK

TABLE OF CONTENTS

WELCOME TO THE JAM!

Professional basketball champion and global icon **LeBron James** goes on an epic adventure alongside timeless Tune **Bugs Bunny** in the animated/live-action event “**Space Jam: A New Legacy.**” This transformational journey is a manic mash-up of two worlds that reveals just how far some parents will go to connect with their kids.

- 1 INTRODUCING THE TUNE SQUAD
- 2 RECIPES
- 5 CONNECT THE DOTS
- 6 COLORING PAGES
- 8 LEARN HOW TO DRAW BUGS BUNNY
- 10 LEARN HOW TO DRAW LOLA BUNNY
- 12 DESIGN YOUR OWN TEAM JERSEY
- 16 DESIGN YOUR OWN TEAM SNEAKERS
- 14 DESIGN YOUR OWN TUNE SQUAD PENNANT
- 15 DESIGN YOUR OWN GOON SQUAD PENNANT
- 16 WORD SCRAMBLE
- 17 WORD SEARCH
- 18 FILL IN THE STORY
- 19 SECRET CODE REVEAL
- 20 FIND THE DIFFERENCE
- 22 PLAY BALL MAZE
- 23 CROSSWORD PUZZLE
- 24 BASKETBALL ORIGAMI HOOP
- 27 CUTOUT HEADBANDS
- 30 BUGS BUNNY CUTOUT MASK
- 34 LOLA BUNNY CUTOUT MASK
- 38 TAZ CUTOUT MASK
- 39 DAFFY DUCK CUTOUT MASK
- 42 SYLVESTER CUTOUT MASK
- 43 TWEETY BIRD CUTOUT MASK
- 45 DESIGN YOUR OWN TRADING CARD

BUGS BUNNY

INTRODUCING THE TUNE SQUAD



BUGS BUNNY

Expert recruiter. Only Bugs can bring the Tune Squad together.



LEBRON JAMES

LeBron is left-handed but he shoots the basketball with his right hand.



LOLA BUNNY

Of all the Tunes, Lola is the most skilled basketball player.

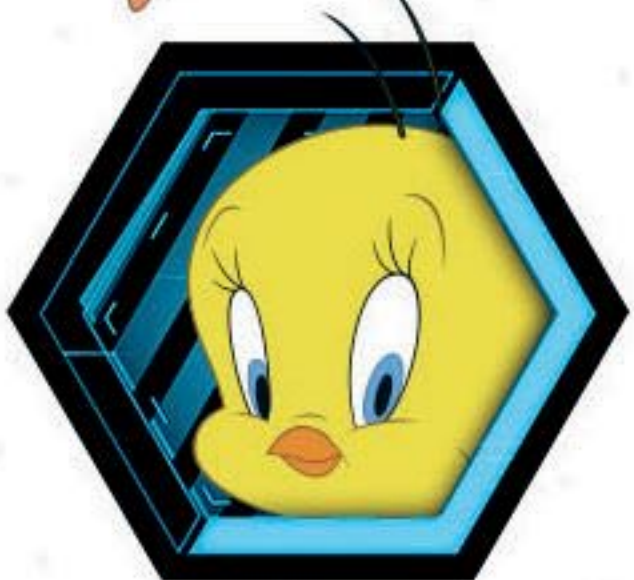

TWEETY BIRD

Expert in the art of a slam dunk.



ELMER FUDD

Elmer's middle initial is J. Could it stand for "Jam"?



WILE E. COYOTE

Has an exclusive endorsement deal with Acme Corporation.



ROAD RUNNER

He's so fast his speed cannot be measured.



FOGHORN LEGHORN

A Leghorn is a type of chicken.



MARVIN THE MARTIAN

Marvin's dog is named K-9 (like "canine" – get it?).



PORKY PIG

Porky has a hidden talent – he can carry a tune – but you'll need to see the movie to experience his mic-drop moment!

BASKETBALL SUGAR COOKIES

MAKES: 30–40 Cookies (based on cookie cutter size)

INGREDIENTS:

Cookie:

1 cup of softened butter
2 eggs
1 ½ cups of sugar
2 teaspoons of vanilla extract
½ teaspoon of baking powder
¼ teaspoon of salt
4 cups of flour
Parchment paper
Circle cookie cutter

Icing:

2 plastic bags for icing
2 ¼ cups of powdered sugar
1 tablespoon of meringue powder
3 tablespoons of water
½ teaspoon of vanilla extract
Black food coloring



DIRECTIONS:

Cookie:

1. Preheat oven to 375°F.
2. Beat butter and sugar until smooth.
3. Add in one egg at a time, mixing well before adding the next one.
4. Next, mix in the vanilla extract, baking powder, and salt.
Once combined, add in the flour one cup at a time.
5. Place dough in the fridge for 20–30 mins. or freezer for 10–15 mins.
Once cold, roll out your dough and place on a parchment paper-lined baking sheet. Using a circle cookie cutter, cut out your basketballs.
6. Bake for 6–9 mins. until golden brown. Let your cookies cool before icing.

Icing:

1. Add powdered sugar and meringue powder to a bowl and mix well.
2. Add in water and vanilla extract and beat until icing forms peaks.
If it is too thick, add a little more water.
3. Split your icing into two bowls and put 5 drops of black food coloring in one and 2 drops of black food coloring in the other.
4. Fill each plastic bag with the colored icing and cut the tip of the bag.
5. Start with the gray frosting and pipe the top of the basketball, starting from the outside working in. Use the back of a spoon or toothpick to spread out the icing to the edges then let harden.
6. Once set, use the black icing to pipe lines down each cookie to make it look like a basketball. Let it set and then enjoy!

CARROT SNACK PACK

INGREDIENTS:

Triangle cellophane bags (purchase at your local craft store)
Green tissue paper
Green string
Orange snacks such as orange bell peppers, carrots, cheddar cheese sticks, orange fish crackers, clementines, cheese puffs

DIRECTIONS:

1. Open your treat bag and fill it with snacks, leaving about one inch of space at the top.
2. Fill the top of the bag with a quarter sheet of green tissue paper.
3. Gather the end of the bag around the tissue paper and tie off with the green string.
4. Finally, cut the ends of the tissue paper into strips to create a leafy look.



TUNES VS. GOONS CUPCAKES

MAKES: 12 Standard-Sized Cupcakes

INGREDIENTS:

Cupcakes:

1/2 cup of softened butter
2 eggs
1 cup of milk
1 1/3 cups of flour
1/4 teaspoon of salt
1 teaspoon of baking powder
1 cup of sugar
1 teaspoon of vanilla extract
Cupcake liners

Frosting:

2 plastic bags for frosting
1/2 cup of softened butter
1 1/2 teaspoons of vanilla extract
2 cups of powdered sugar
2 tablespoons of milk
Red, yellow, and blue food coloring

Cupcake Toppers:

Tunes vs. Goons cupcake toppers
Toothpicks
Tape



DIRECTIONS:

Cupcake:

1. Preheat the oven to 350°F/190°C and line cupcake tins with cupcake liners.
2. Beat butter and sugar together with an electric mixer or spoon until light and fluffy.
3. Mix in one egg at a time. Wait until the first one is combined before adding the second. Add vanilla extract.
4. In a separate bowl, mix together the dry ingredients. Once combined, slowly add in half of the dry ingredients to the butter mixture until just combined.
5. Next, add milk and mix until combined then add in the remaining dry ingredients.
6. Divide the batter between the cupcake tins until each is 3/4 full.
7. Bake for 15–20 mins. until an inserted toothpick comes out clean.
8. Remove cupcakes from tin and let cool completely before frosting.

Frosting:

1. With an electric mixer or spoon, beat the softened butter until fluffy and smooth.
2. Next, mix in powdered sugar until combined. Add in vanilla extract.
3. Add in milk and beat until combined.
4. Split the frosting into three bowls. Add 3 drops of blue food coloring into the first bowl, 2 drops of yellow and 1 drop of red food coloring into the second bowl, and 3 drops of red and 1 drop of blue food coloring into the third bowl.
5. Stir each individual bowl until colors are thoroughly mixed together.
6. Scoop each color frosting into its own plastic bag and push the frosting into a corner of the bag.
7. Cut the tip of the bag and frost your cooled cupcakes.

Cupcake Toppers:

1. Cut out the Tunes vs. Goons cupcake toppers on the next page.
2. Place the toothpick on the back side of the topper and tape into place.
3. Stick toppers into the cupcakes and enjoy!

**SPACE
JAM**
A NEW LEGACY

JULY 16 IN THEATERS | SEE IT **AND ON** **HBOMAX**
ONLY AVAILABLE ON THE AD-FREE PLAN

TUNES VS. GOONS

CUPCAKE TOPPERS



CONNECT THE DOTS



**SPACE
JAM**
A NEW LEGACY

JULY 16 IN THEATERS | **SEE IT** **AND ON** **HBOMAX**
ONLY AVAILABLE ON THE AD-FREE PLAN

COLORING PAGES

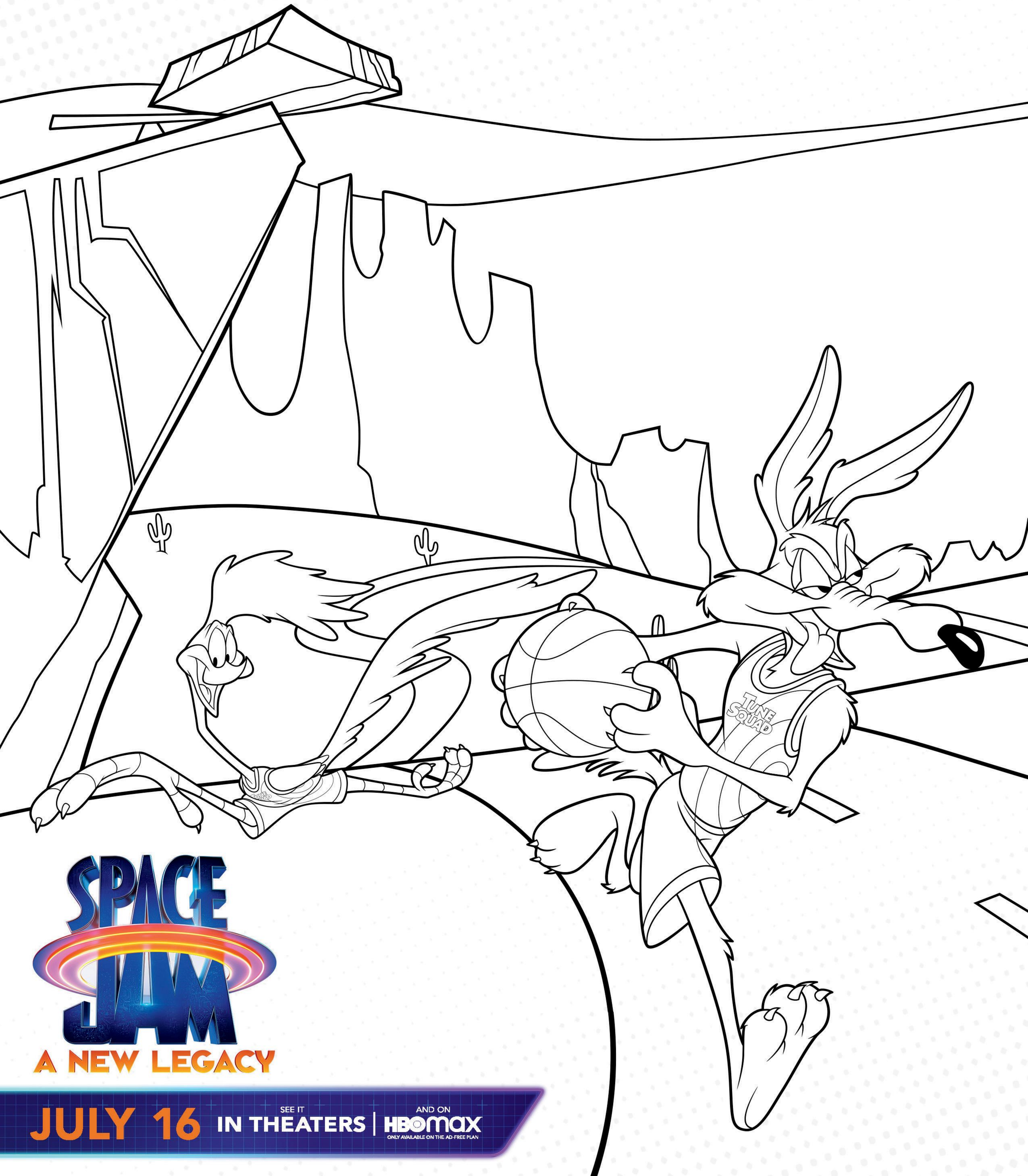

**SPACE
JAM**
A NEW LEGACY

JULY 16

SEE IT
IN THEATERS

AND ON
HBOMAX
ONLY AVAILABLE ON THE AD-FREE PLAN



**SPACE
JAM**
A NEW LEGACY

JULY 16 SEE IT **IN THEATERS** | **AND ON** **HBOMAX**
ONLY AVAILABLE ON THE AD-FREE PLAN

LEARN HOW TO

DRAW BUGS BUNNY

Follow the steps to draw your own Bugs Bunny!

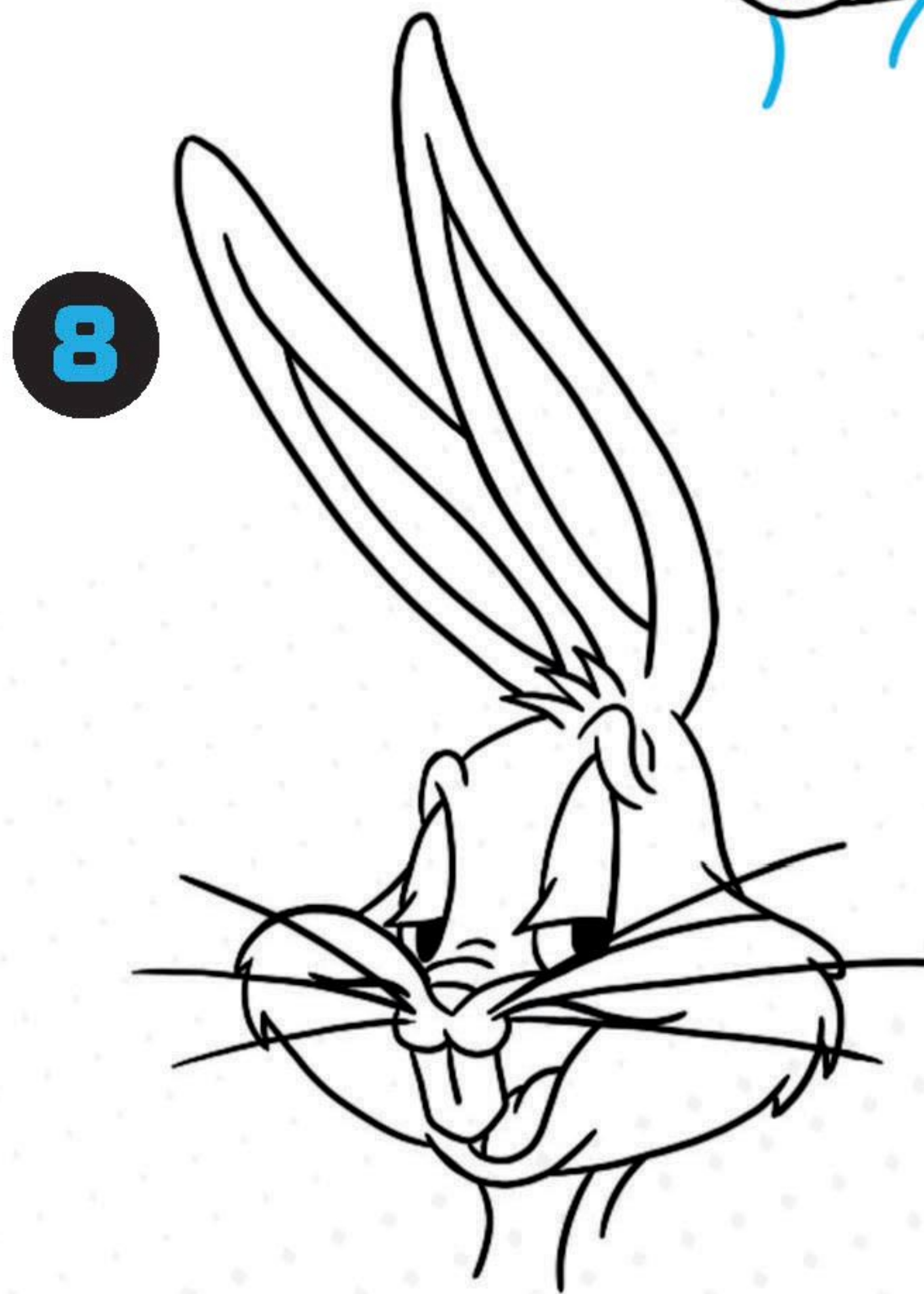
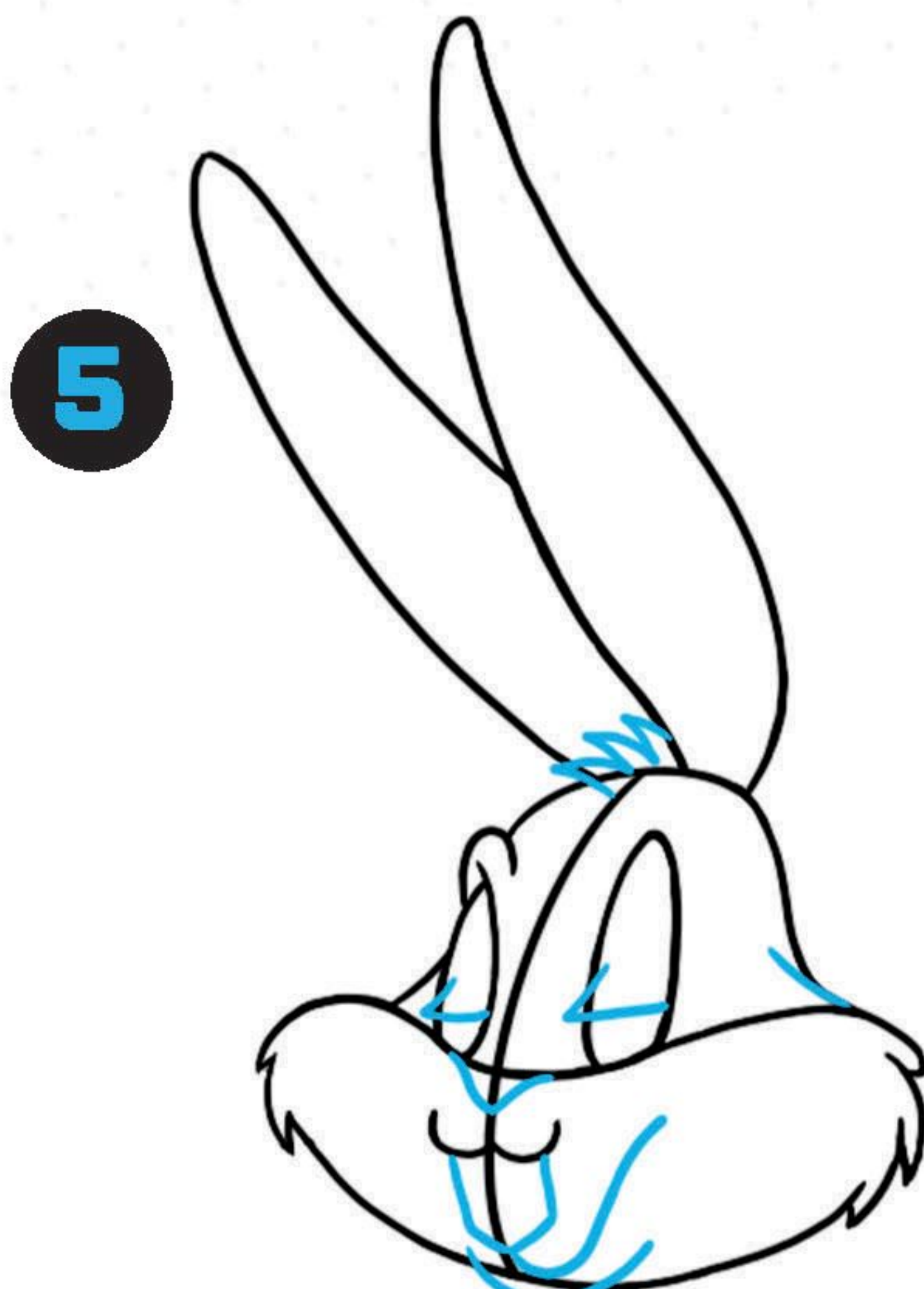
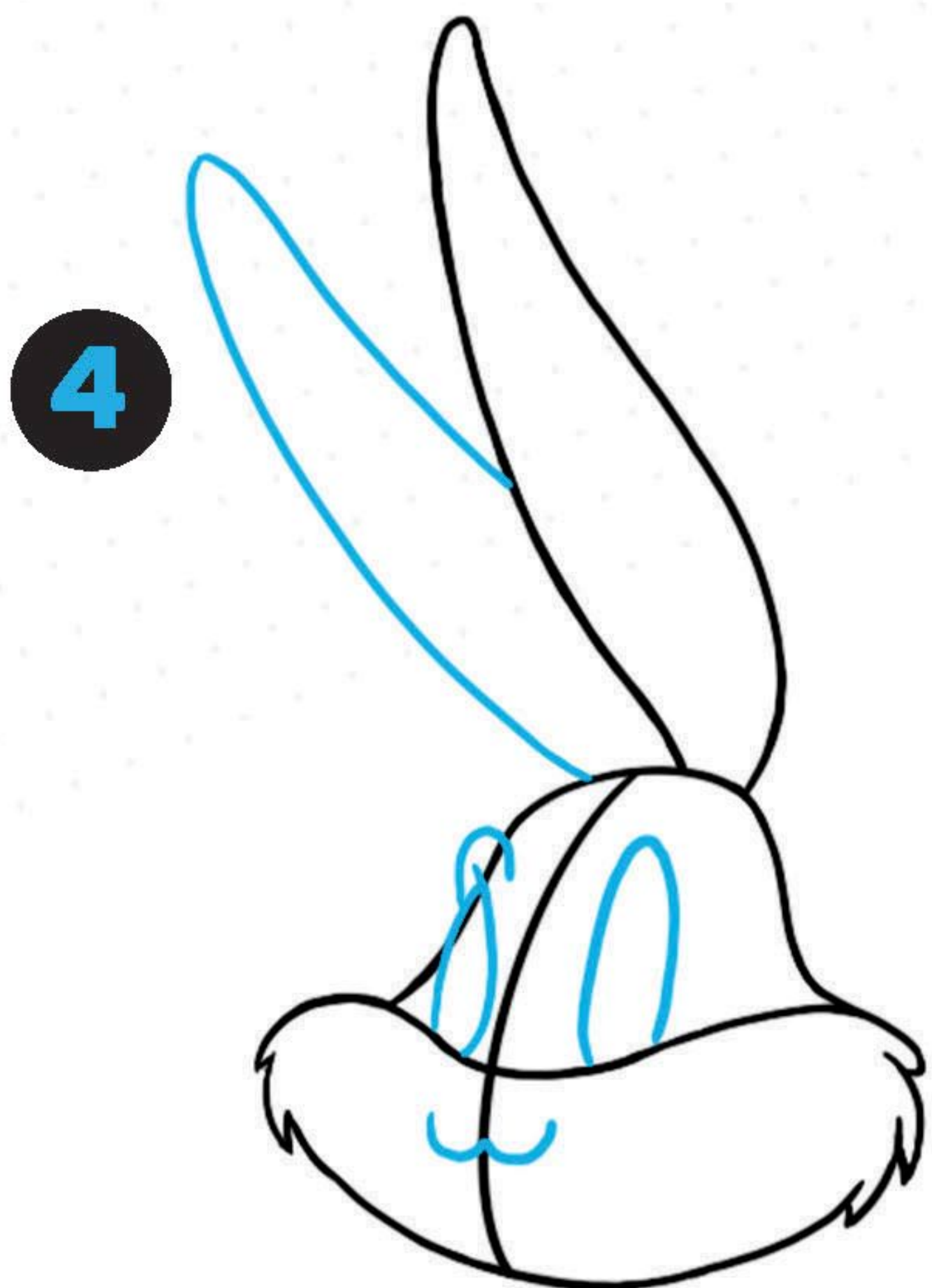
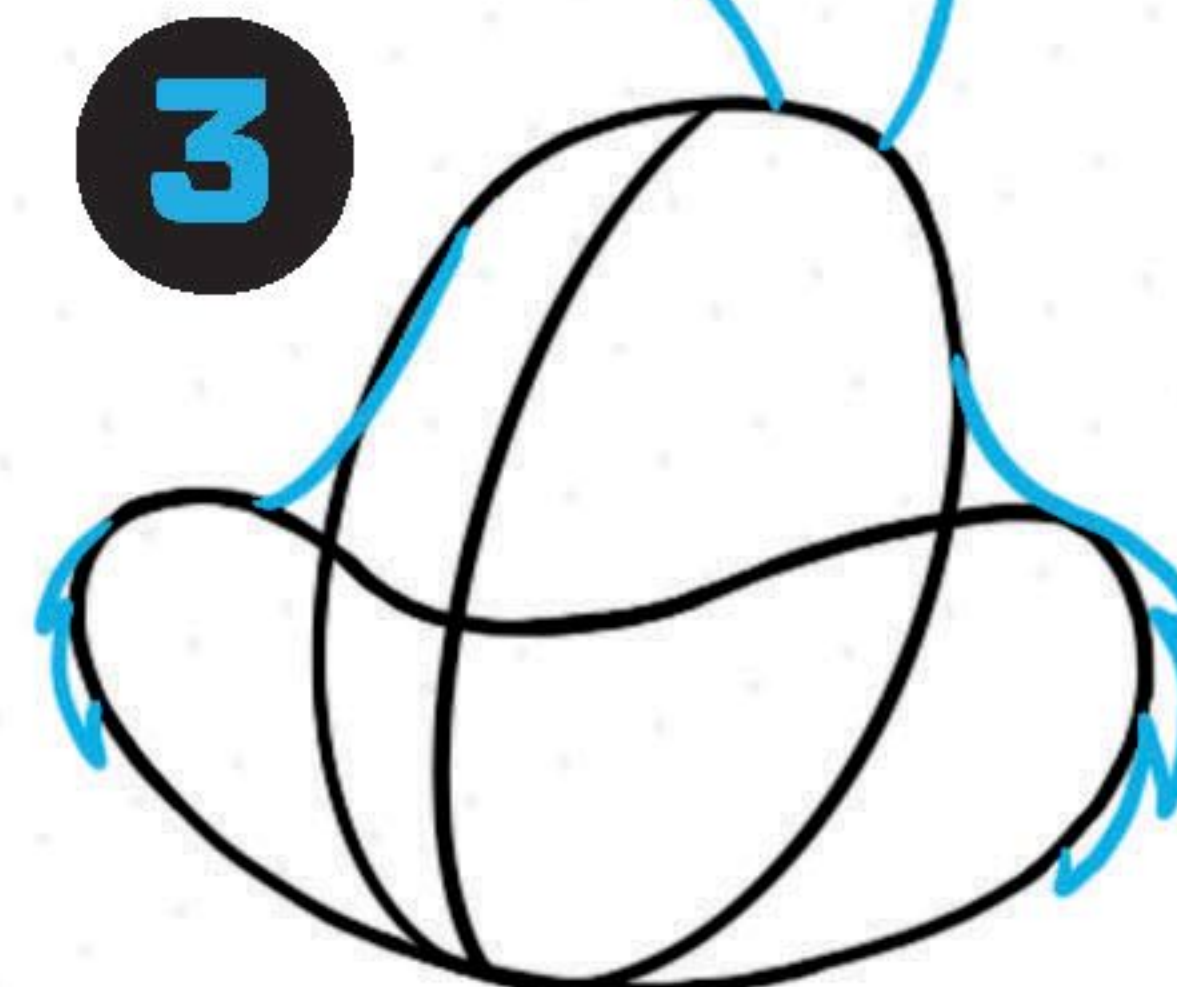
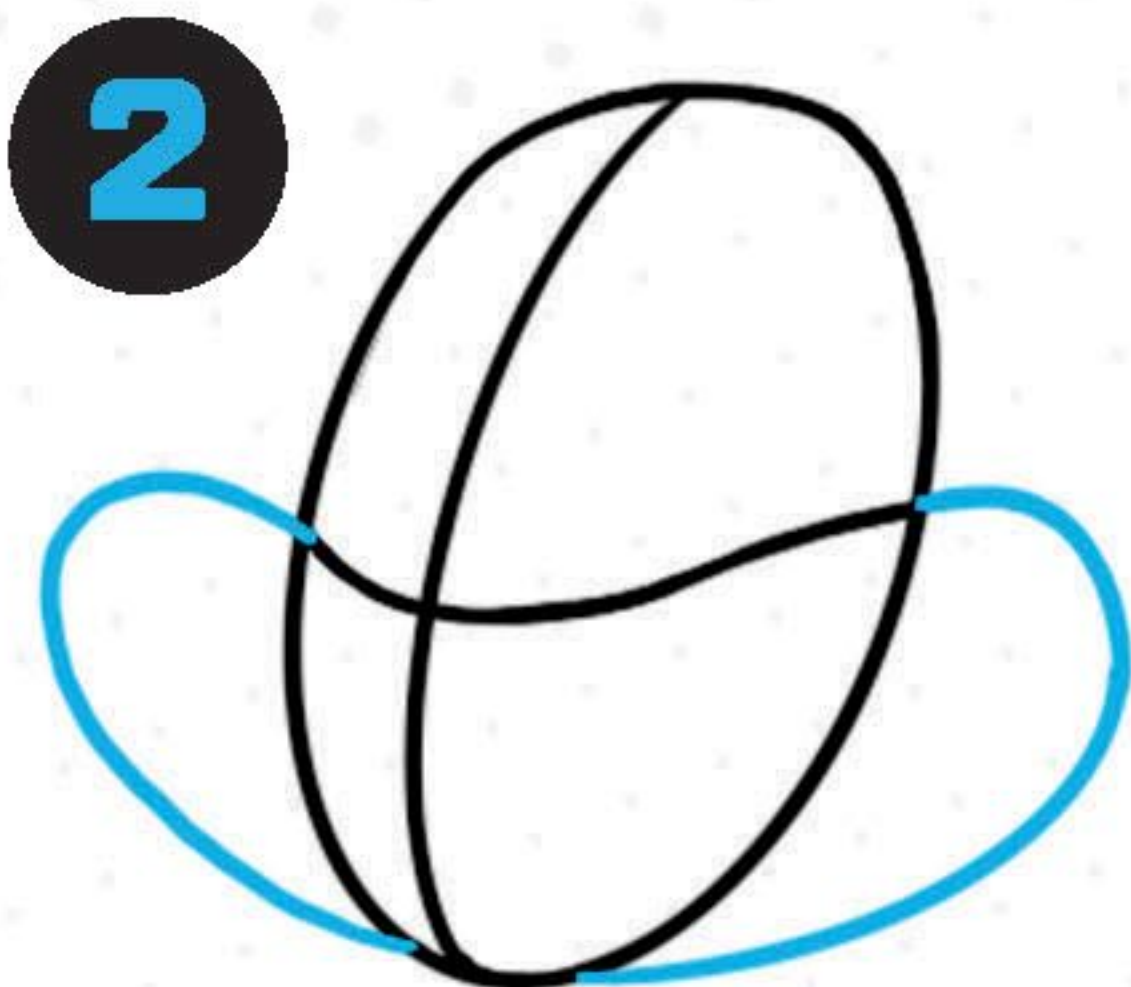
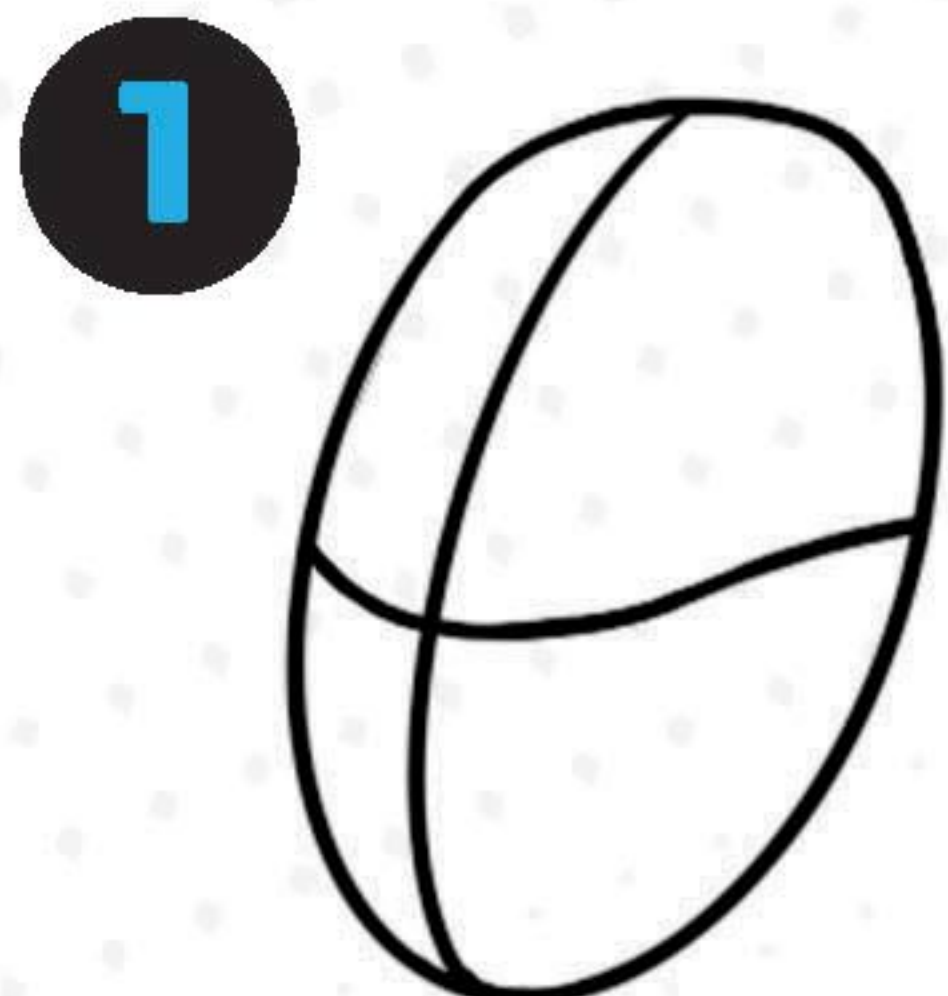

**SPACE
JAM**
A NEW LEGACY

JULY 16

SEE IT
IN THEATERS

AND ON
HBOMAX
ONLY AVAILABLE ON THE AD-FREE PLAN



DRAW HERE

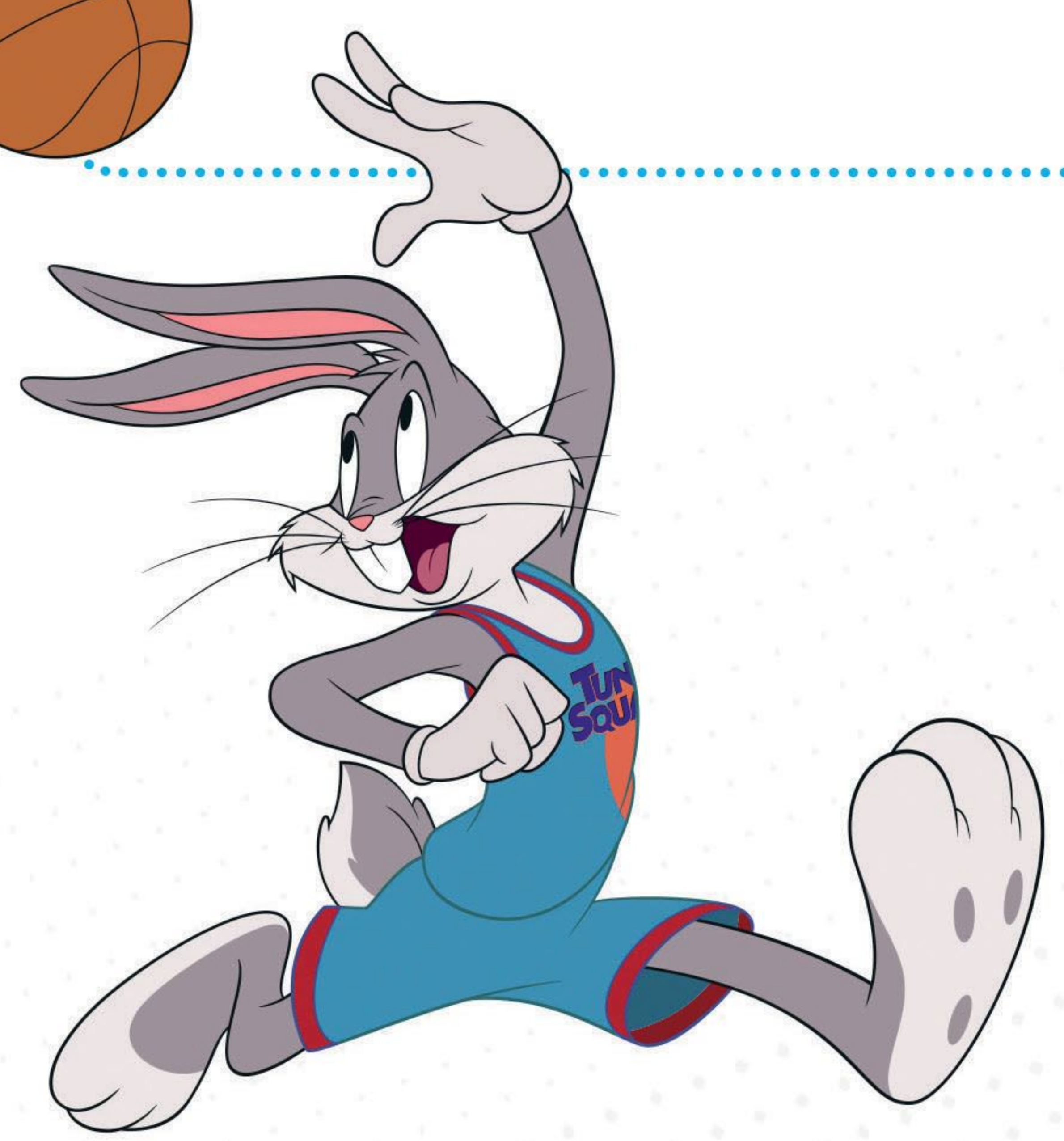
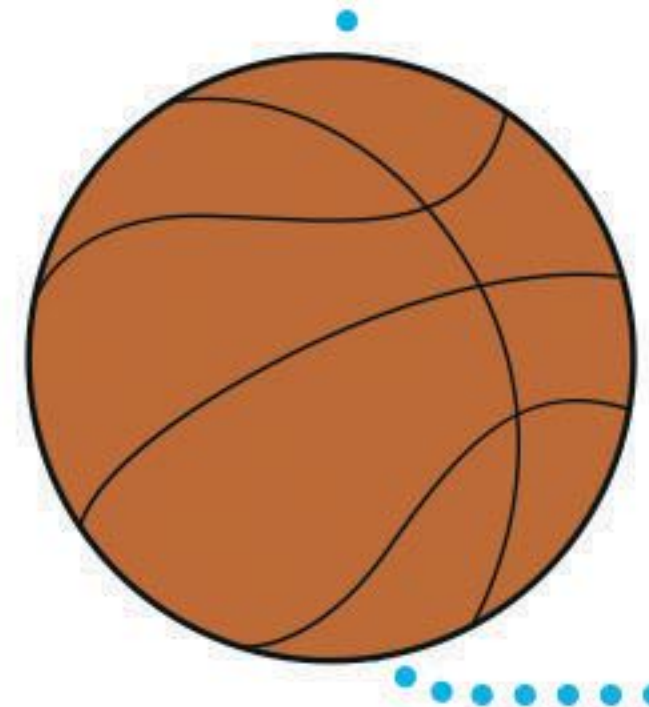

**SPACE
JAM**
A NEW LEGACY

JULY 16

SEE IT **IN THEATERS**

AND ON **HBOMAX**
ONLY AVAILABLE ON THE AD-FREE PLAN

LEARN HOW TO

DRAW LOLA BUNNY

Follow the steps to draw your own Lola Bunny!



1



2

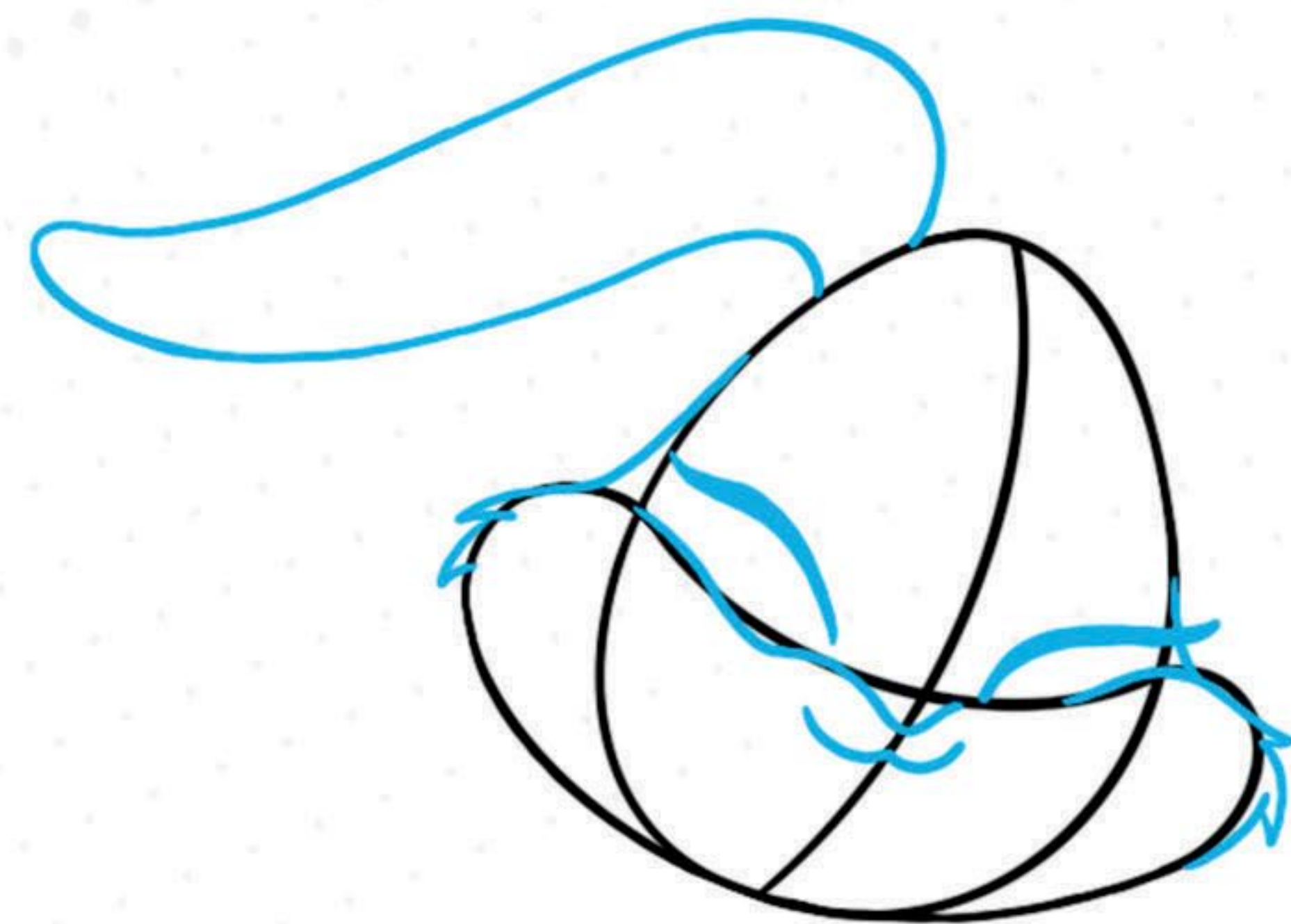

3

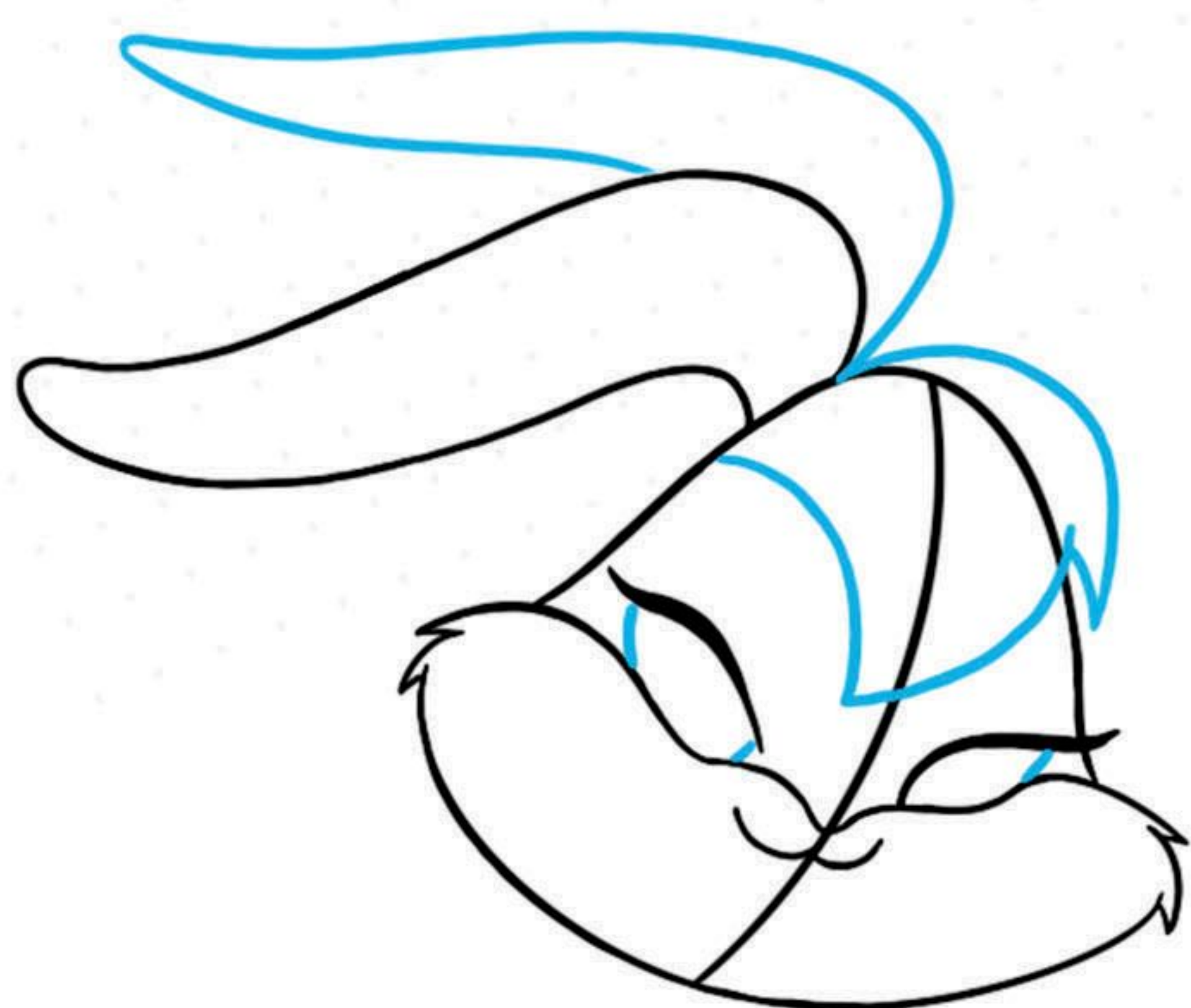

4

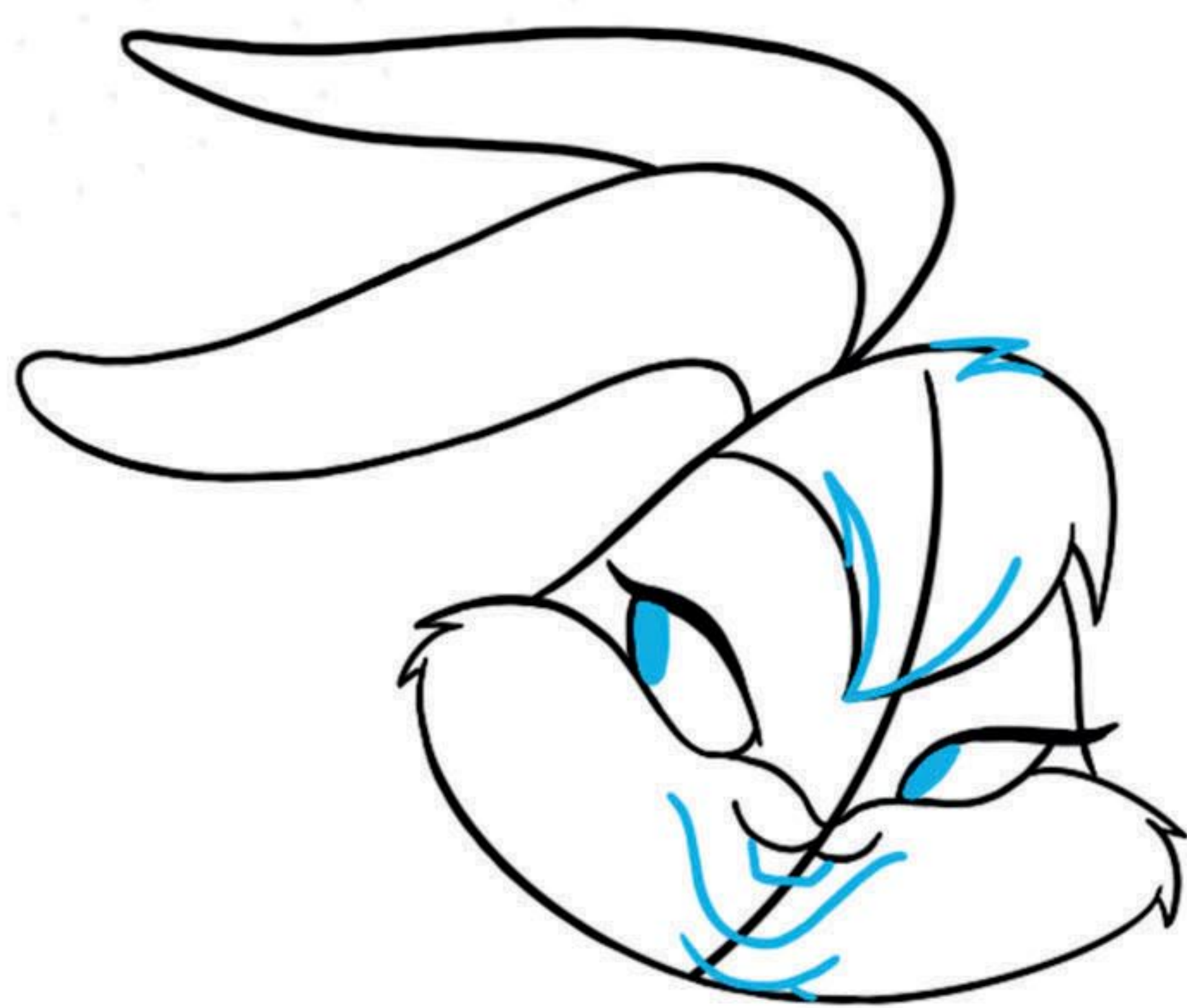

5



6



7



8



JULY 16

SEE IT IN THEATERS

AND ON **HBOMAX**
ONLY AVAILABLE ON THE AD-FREE PLAN



DRAW HERE

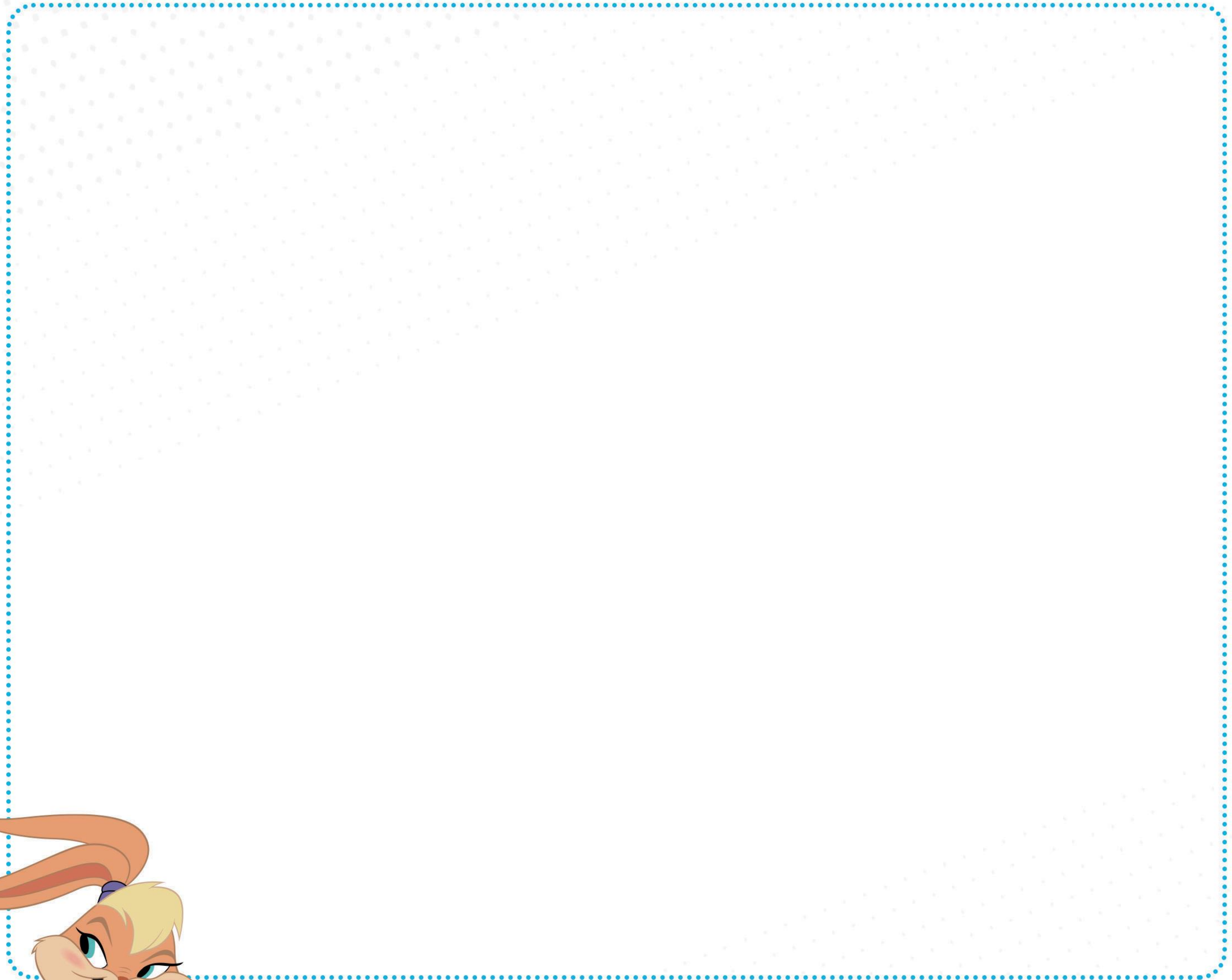

**SPACE
JAM**
A NEW LEGACY

JULY 16 SEE IT **IN THEATERS** | **AND ON** **HBOMAX**
ONLY AVAILABLE ON THE AD-FREE PLAN

DESIGN YOUR OWN TEAM JERSEY

Draw and color to design your own jersey.



DESIGN YOUR OWN
TEAM SNEAKERS

Draw and color to design your own sneakers.



**SPACE
JAM**
A NEW LEGACY

JULY 16 SEE IT **IN THEATERS** | **AND ON** **HBOMAX**
ONLY AVAILABLE ON THE AD-FREE PLAN

DESIGN YOUR OWN

TUNE SQUAD PENNANT

Fold on the dotted line; glue on a stick, string or straw.

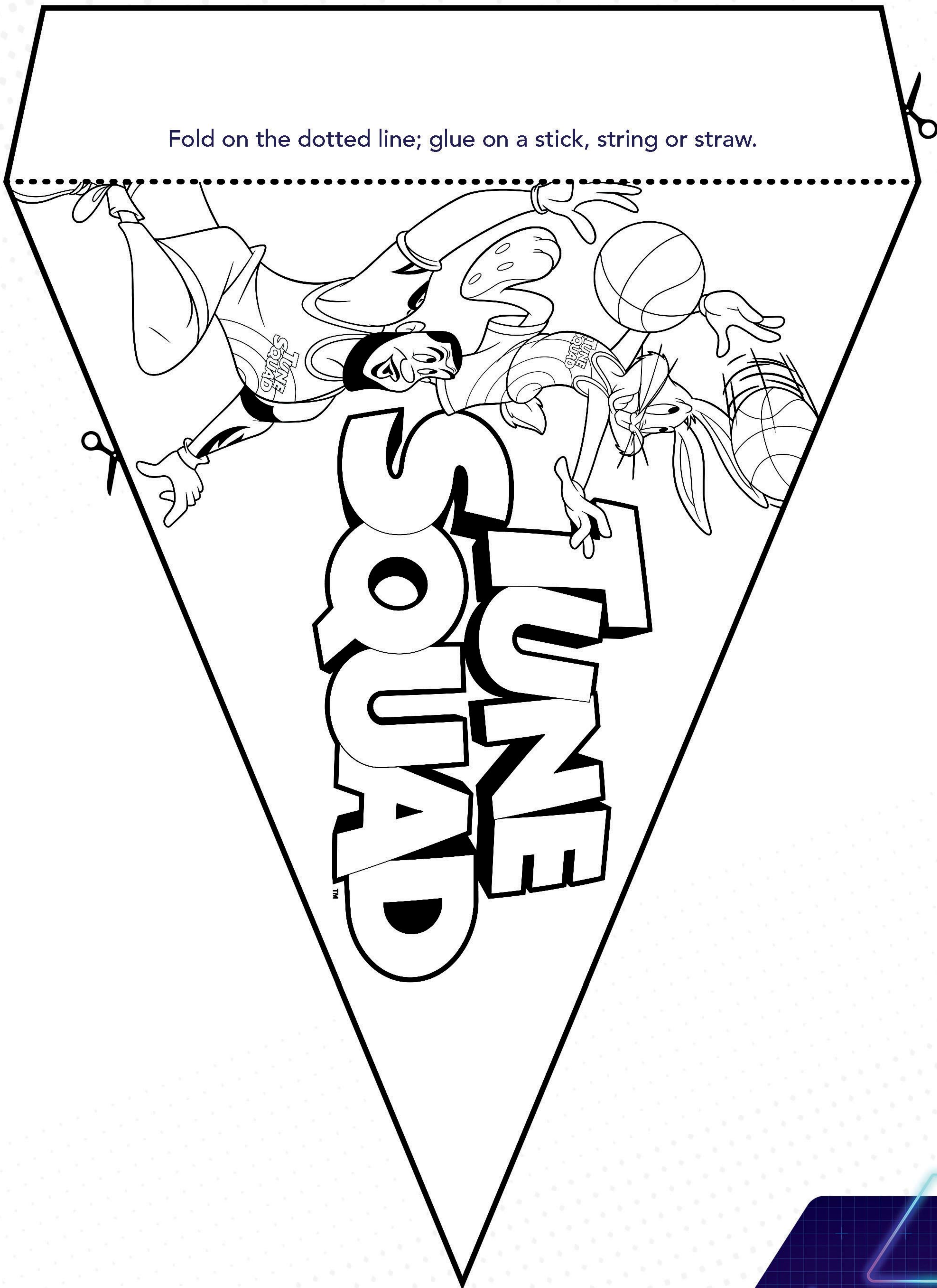

DESIGN YOUR OWN

GOON SQUAD PENNANT

Fold on the dotted line; glue on a stick, string or straw.

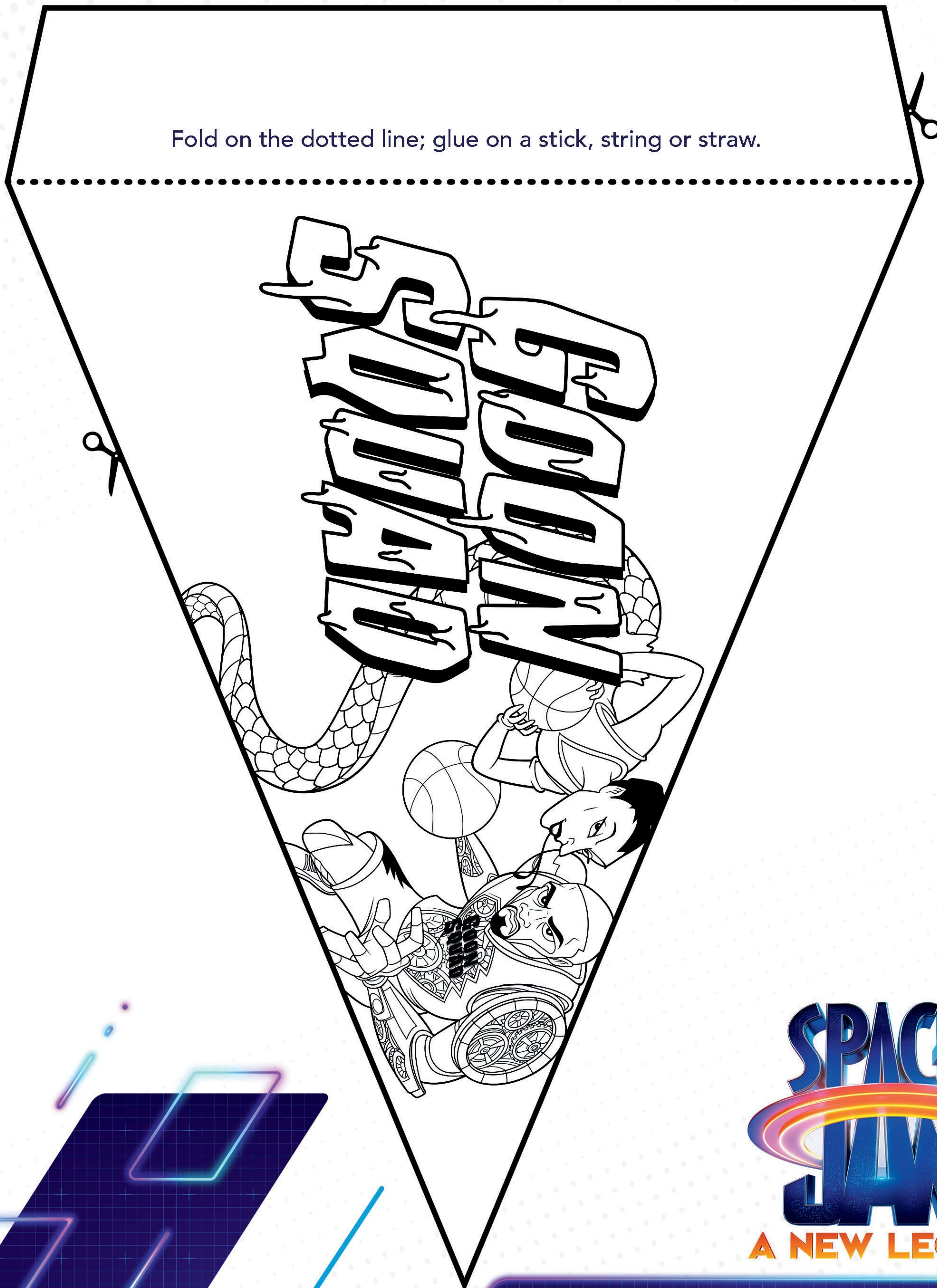

**SPACE
JAM**
A NEW LEGACY

JULY 16

SEE IT
IN THEATERS

AND ON
HBOMAX
ONLY AVAILABLE ON THE AD-FREE PLAN

WILD TUNE SQUAD

WORD SCRAMBLE

Unscramble the words to help LeBron discover his team.

OPRYK GIP

1. _____

ANTASIMAN EVLDI

2. _____

UGBS YNBUN

3. _____

ETYWTE

4. _____

FAFYD CUDK

5. _____

DARO NURNRE

6. _____

EELRM FDDU

7. _____

ITYMSEEO SMA

8. _____

9. _____

10. _____

11. _____

12. _____

13. _____

14. _____

15. _____



LVESRTSYE

OLLA NNYUB

HRONFGO EHNRGLO

PESEYD EZNSOGLA

AGNRYN

WLEI E YECTOO

SSGMEOAR



JULY 16

SEE IT IN THEATERS

AND ON **HBOMAX**
ONLY AVAILABLE ON THE AD-FREE PLAN

WASCALLY WABBIT'S WORD SEARCH

Find the following words in the puzzle. Words are hidden ↓, ↑, →, ←, and ↘.

AUSTIN POWERS
BASKETBALL
BATMAN
BUGS BUNNY
CASABLANCA
CHRONOS

FLINTSTONES
GAME OF THRONES
HARRY POTTER
INDIGO WIDOW
IRON GIANT
KING JAMES

KING KONG
MAD MAX
PORKY PIG
ROAD RUNNER
SUPERMAN
TEAMWORK

THE BROW
THE MATRIX
TWEETY
WET FIRE
WHITE MAMBA
WONDER WOMAN

I L A F N A M R E P U S T A J E A F N Q D W K
S J E M T U V D U D K H A H L A X F W N R B B
E G E G E Y A T X A M D A M E O I S E A V L A
N Q V K A X W U T T W G F A J M A C T M A H S
O E W I M L W W S B W W I L E I A A F T A A K
R O O N W W H O P T P E R N I D Y T I A J R E
H S D G O A I N Y O I T E O U N O U R B V R T
T E I K R C T D A Y R N H T A V T C E I Z Y B
F M W O K N E E D I H K P E Y D K S M E X P A
O A O N T A M R V H Q Y Y O B U R I T R L O L
E J G G S L A W T D A I A P W R C U G O I T L
M G I P K B M O X H M G V O I E O K N M N T M
A N D V Y A B M D A H K N L Q G R W O N G E F
G I N V N S A A I R O N G I A N T S D H E R S
H K I V S A A N X B K R Y C H R O N O S Q R H
R M G N A C O N Y N N U B S G U B R W A Y A T



**SPACE
JAM**
A NEW LEGACY

JULY 16 IN THEATERS | SEE IT AND ON **HBOMAX**
ONLY AVAILABLE ON THE AD-FREE PLAN

FILL IN THE STORY

WELCOME TO THE JAM!

Professional basketball champion and global icon _____ goes
on a(n) _____ adventure alongside timeless Tune _____ in the
animated/live-action event "Space Jam: A New Legacy." This _____
journey is a manic mash-up of _____ worlds that reveals just how
far some parents will go to connect with their kids.

When _____ and his/her young son Dom
are trapped in a _____ by a rogue A.I., _____
must get them home safe by leading Bugs, Lola Bunny and
the whole gang of notoriously _____ Looney Tunes to
victory over the A.I.'s digitized champions on the court: a
powered-up roster of professional _____ stars
as you've never seen them before. It's Tunes versus
Goons in the highest-stakes challenge of their life, that will
redefine _____'s bond with his/her son and shine a light
on the power of being yourself. The ready-for-action Tunes destroy
convention, supercharge their unique talents, and surprise even

"King"/"Queen" _____ by _____
the game their own way.







JULY 16 SEE IT **IN THEATERS** | AND ON **HBOMAX**
ONLY AVAILABLE ON THE AD-FREE PLAN



SECRET CODE REVEAL



Crack the Looney Tunes key phrases by using the secret code alphabet!



1: _____ , _____ ?



    _____

  _____









  









2: _____ !

     _____





         





3: _____ !





        _____

4: _____ !

    _____

    _____



JULY 16 IN THEATERS | **HBOMAX** ONLY AVAILABLE ON THE AD-FREE PLAN

FIND THE DIFFERENCE

Can you find 12 differences between the two pictures?



**SPACE
JAM**
A NEW LEGACY

JULY 16 SEE IT **IN THEATERS** | **AND ON** **HBOMAX**
ONLY AVAILABLE ON THE AD-FREE PLAN





SPACE JAM

A NEW LEGACY

JULY 16 SEE IT **IN THEATERS** | **AND ON** **HBOMAX**
ONLY AVAILABLE ON THE AD-FREE PLAN

PLAY BALL MAZE

Find the correct path to help Bugs score a basket for the Tune Squad.

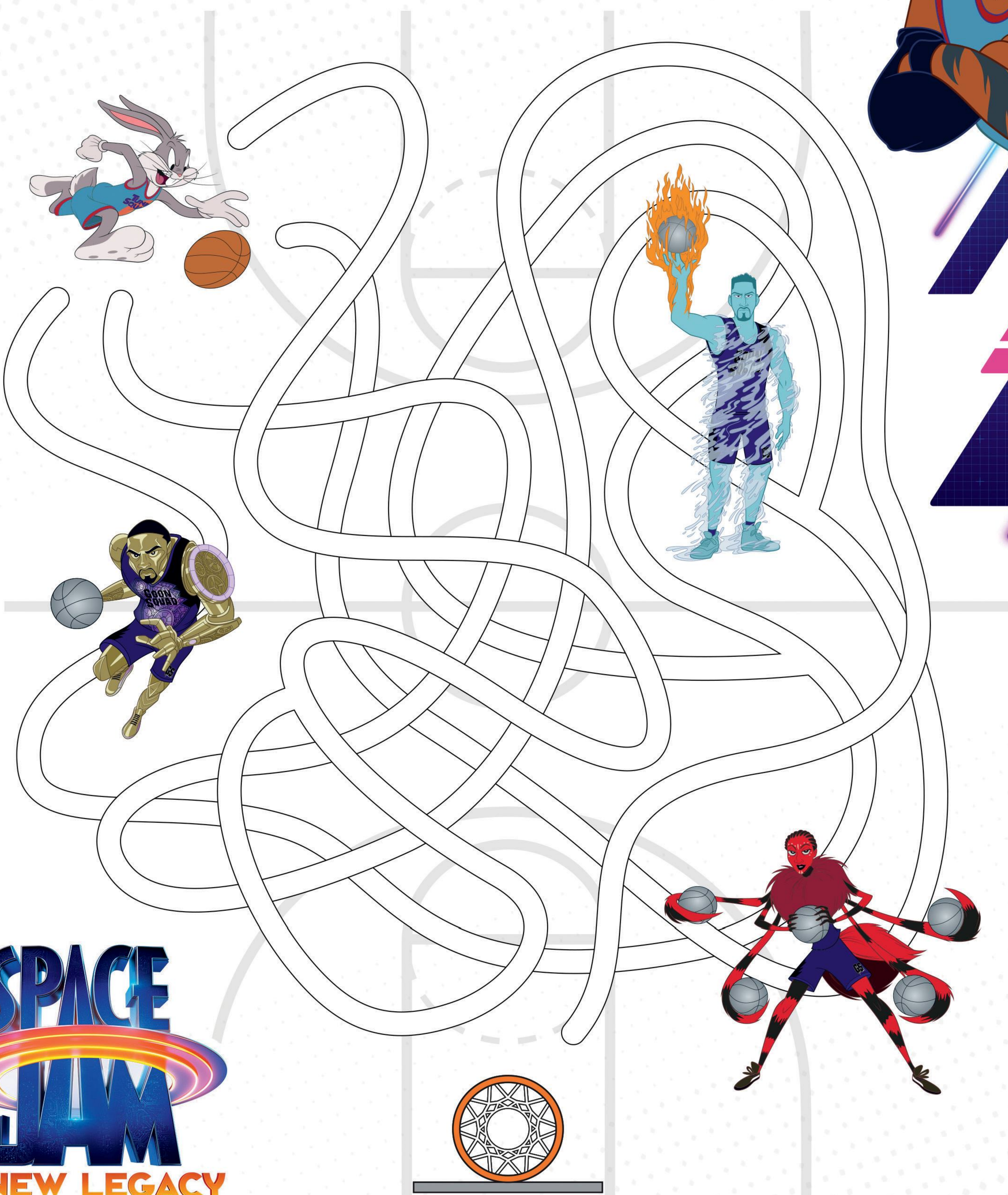

**SPACE
JAM**
A NEW LEGACY

JULY 16

SEE IT
IN THEATERS

AND ON
HBOMAX
ONLY AVAILABLE ON THE AD-FREE PLAN

READ THE CLUES BELOW TO SOLVE THE CROSSWORD PUZZLE

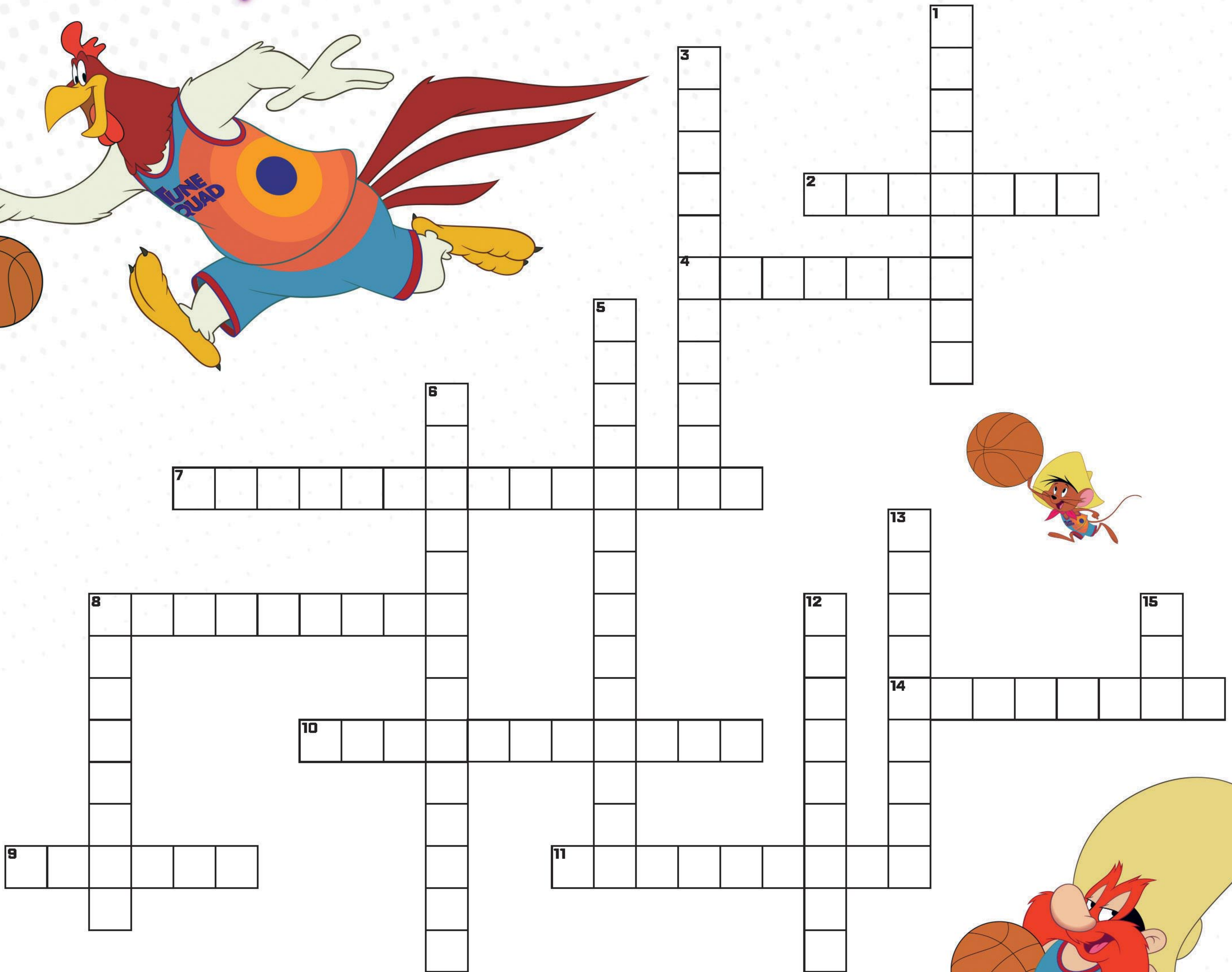

ACROSS

2. When you bounce the ball on the floor to move from one end of the court to the other.
4. What does LeBron turn into when Al-G sends LeBron to Looney Tunes World?
7. Although there are lots of fast members of the Tune Squad, his compact size allows him to blast past the Goons and head straight for the basket.
8. He is a good basketball player but is easily distracted by yarn and must fight the temptation to chase his teammate Tweety.
9. A sweet, sassy old lady who is good at basketball.
10. Not the tallest on the team but at least his hat gives him a couple of inches.
11. Normally, he likes to chase Bugs ("Stop, you wascally wabbit!") through the woods, but once he joins the Tune Squad, he chases the ball up and down the wooden court.
14. A _____ is when you jump in the air and score by putting the basketball directly through the hoop above the rim.

DOWN

1. She is the best basketball player on the court besides LeBron.
3. Although he isn't much of a trash-talker, he lets his playing do the talking. He's in great shape from constantly chasing the Road Runner so he is an asset to the Tune Squad.
5. This player can turn into a whirling tornado of destruction.
6. This is one fowl who's not afraid to foul! The Goons don't scare him — once he steps onto the court, he's no chicken.
8. LeBron James and Bugs Bunny go on an epic animated/live-action adventure called _____.
12. The team that LeBron plays on.
13. Al-G Rhythm's basketball team.
15. Basketball is all about having ____.

**SPACE
JAM**
A NEW LEGACY

JULY 16 IN THEATERS | SEE IT AND ON **HBOMAX**
ONLY AVAILABLE ON THE AD-FREE PLAN

BASKETBALL ORIGAMI HOOP

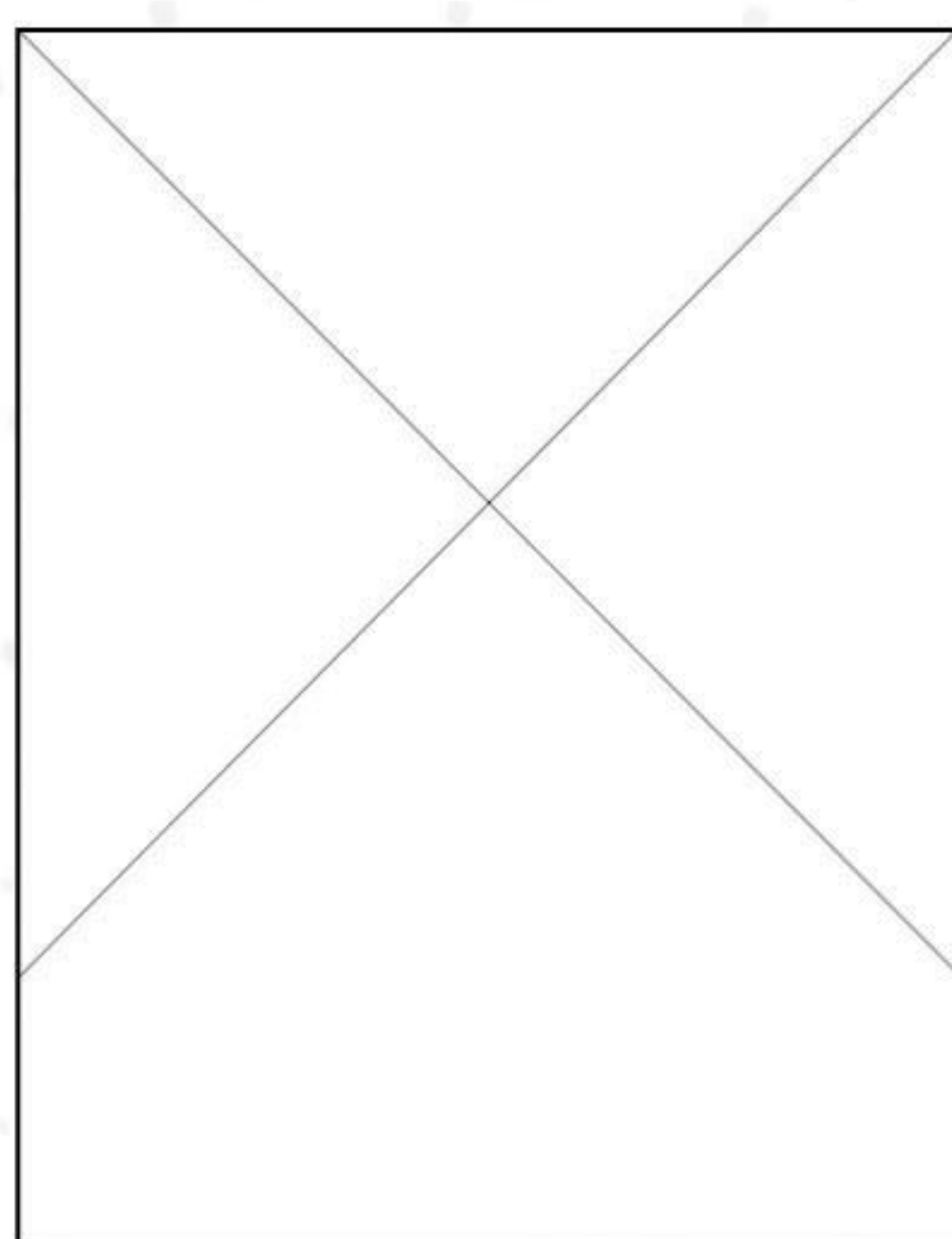
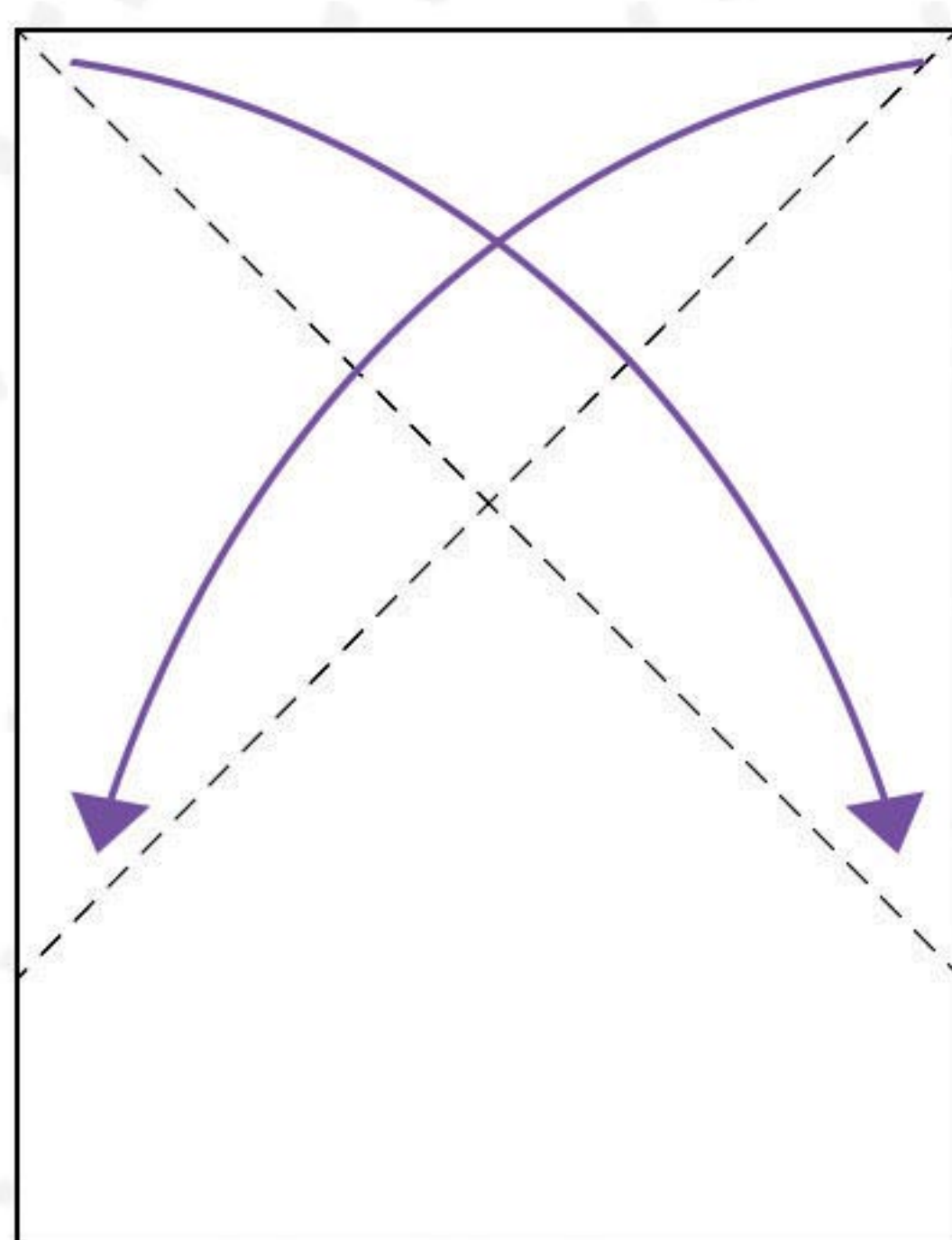

Step 1: Fold the top right and left corners down to form a triangle.

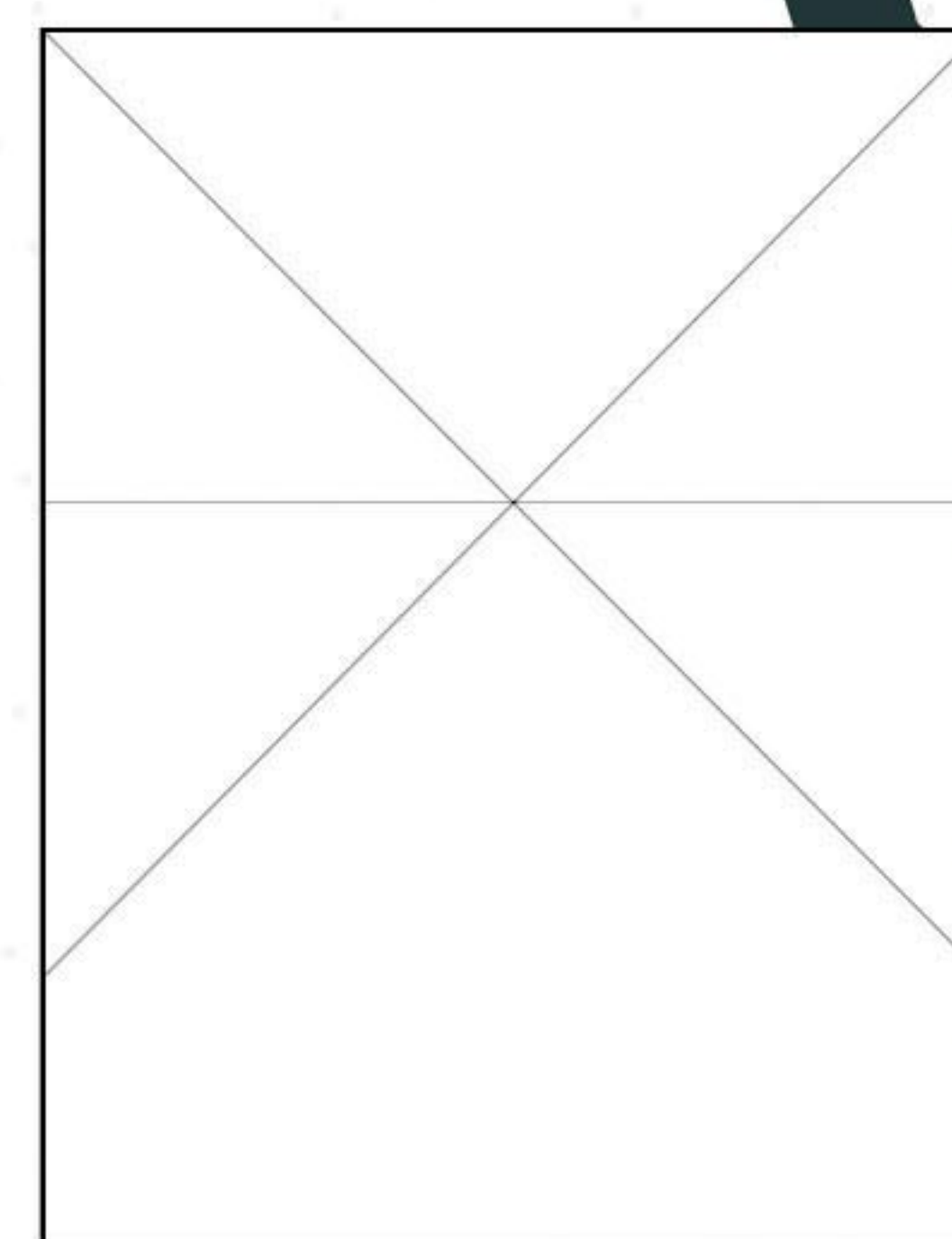
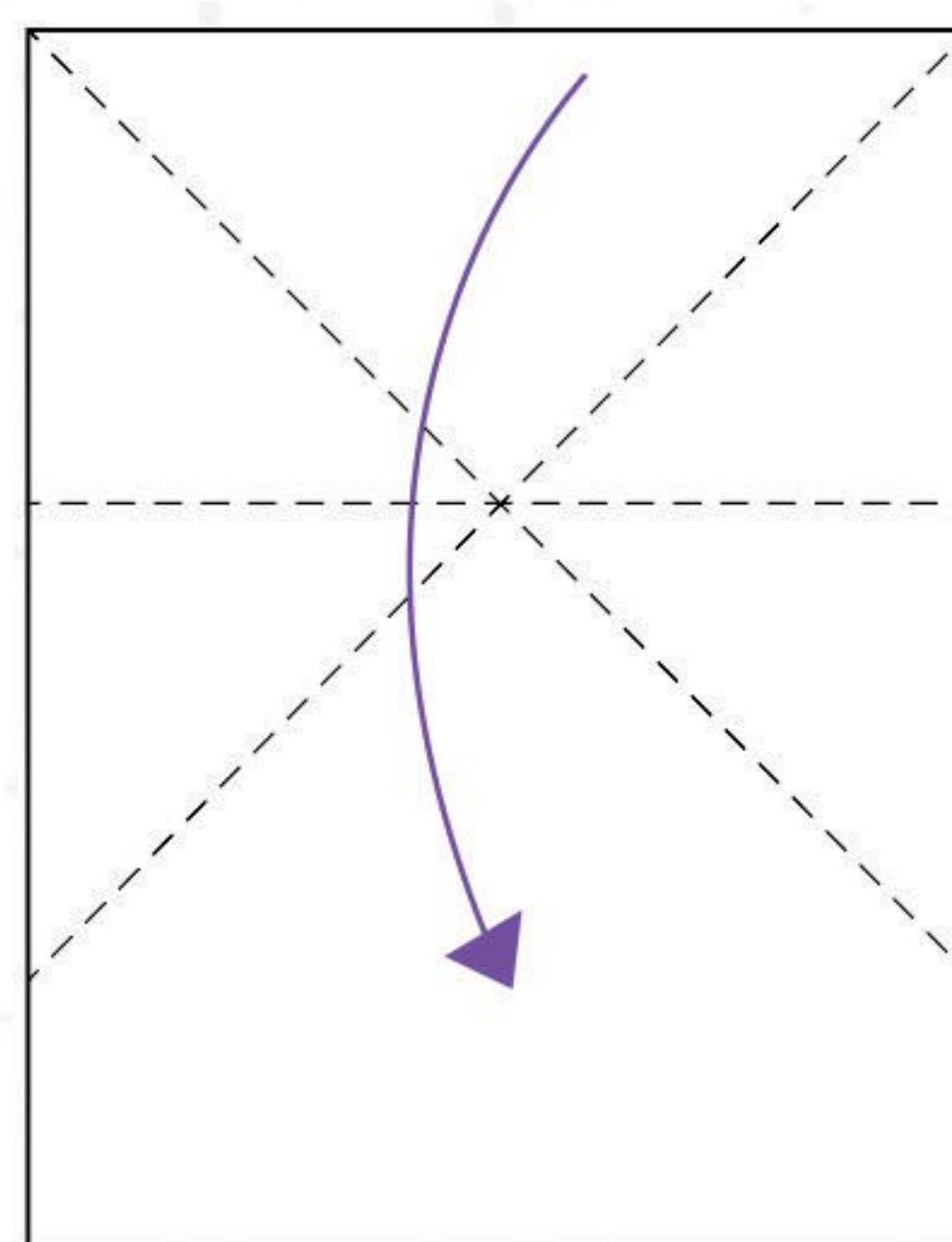

Step 2: Fold the paper down from the top so that the fold intersects with the center of the previous folds.

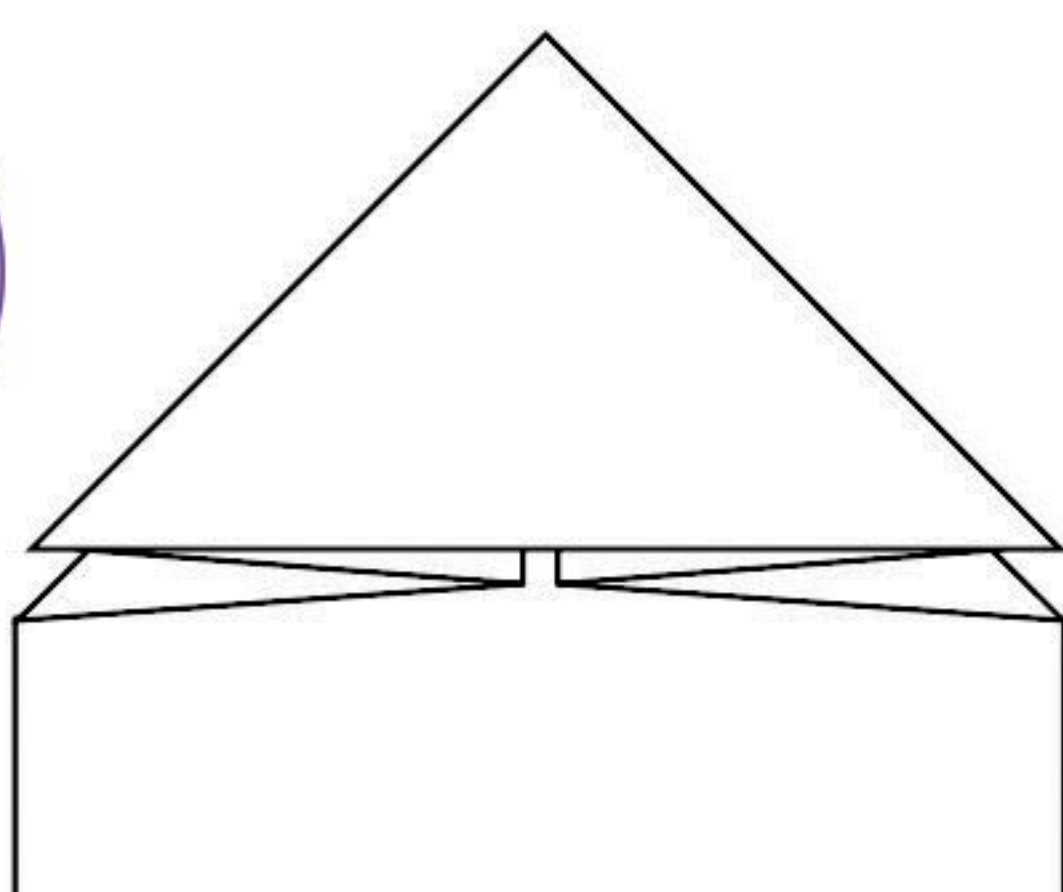
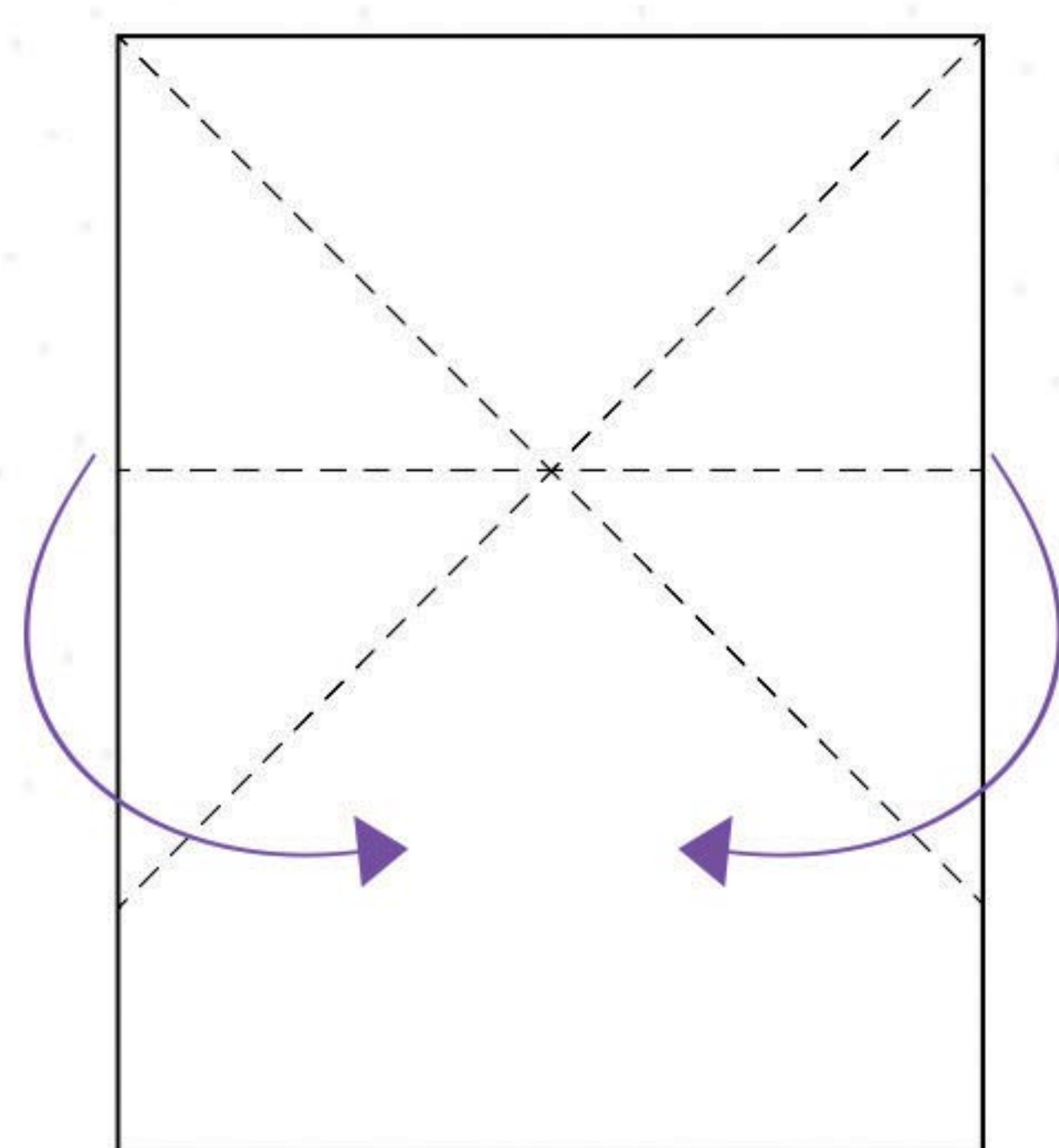

Step 3: Push in the center of where the three creases meet and then flatten the triangle down.

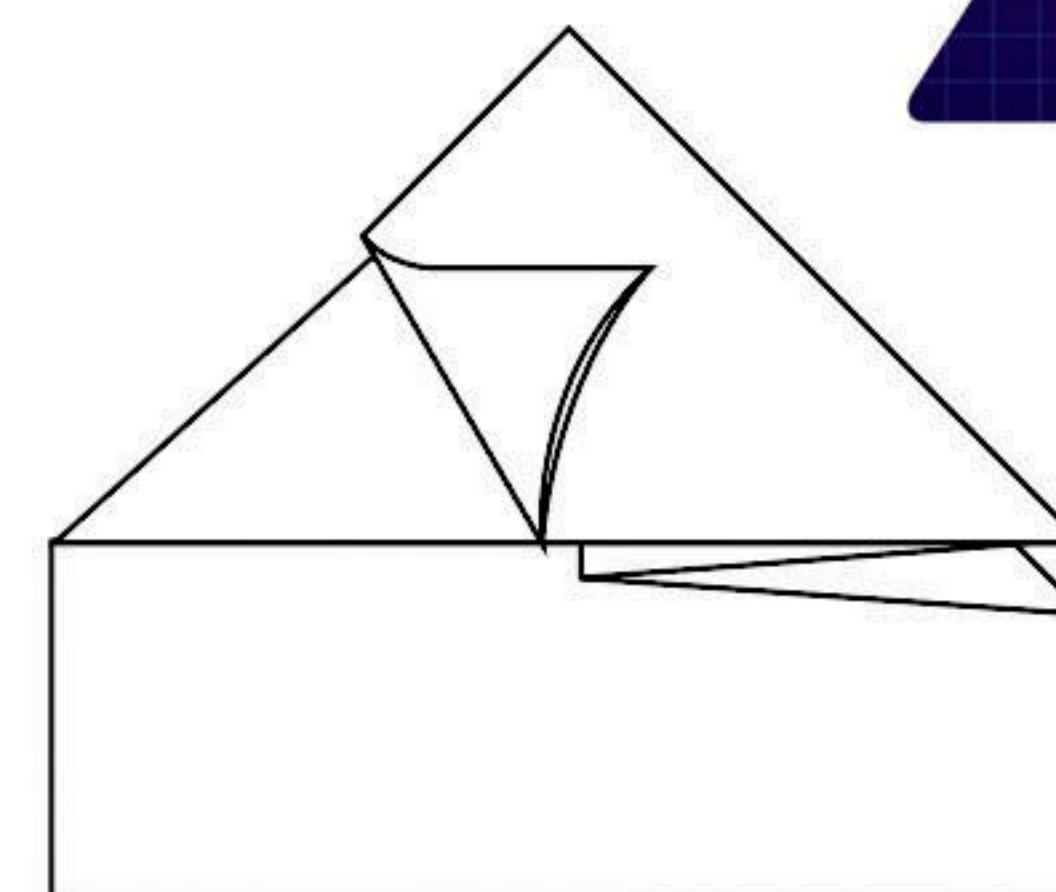
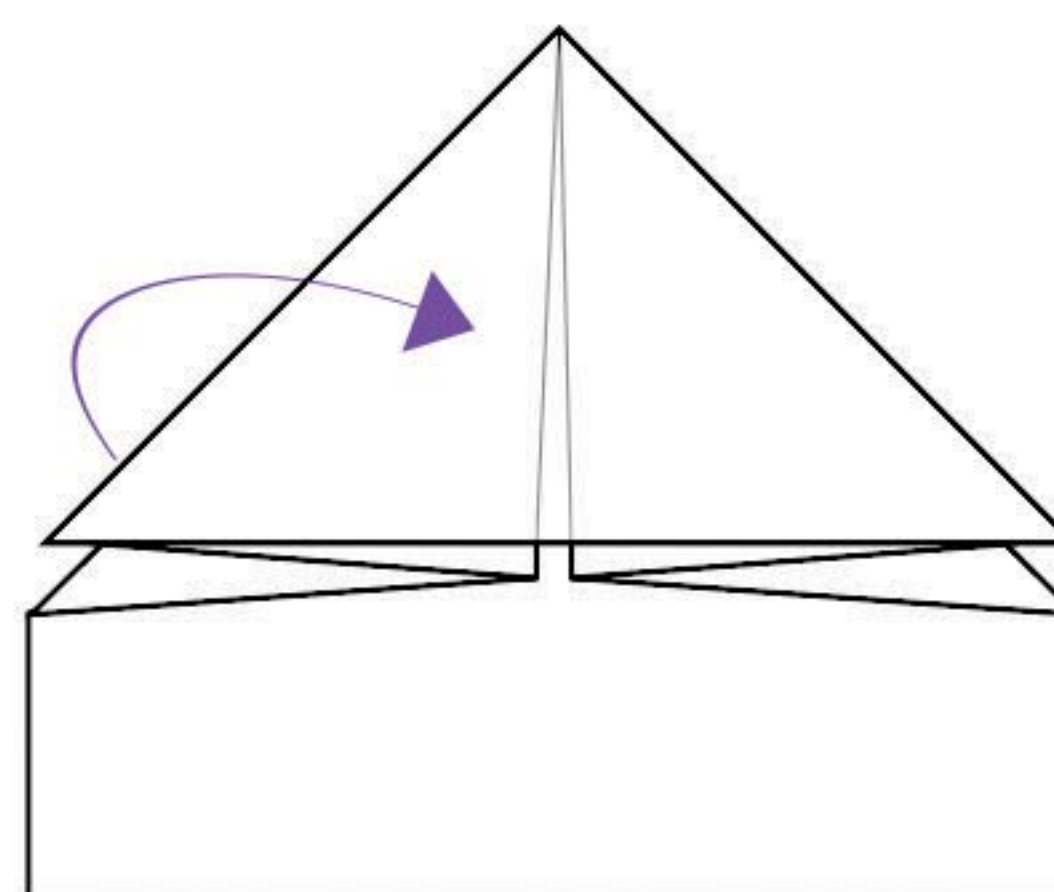

Step 4: Fold over the left flap.

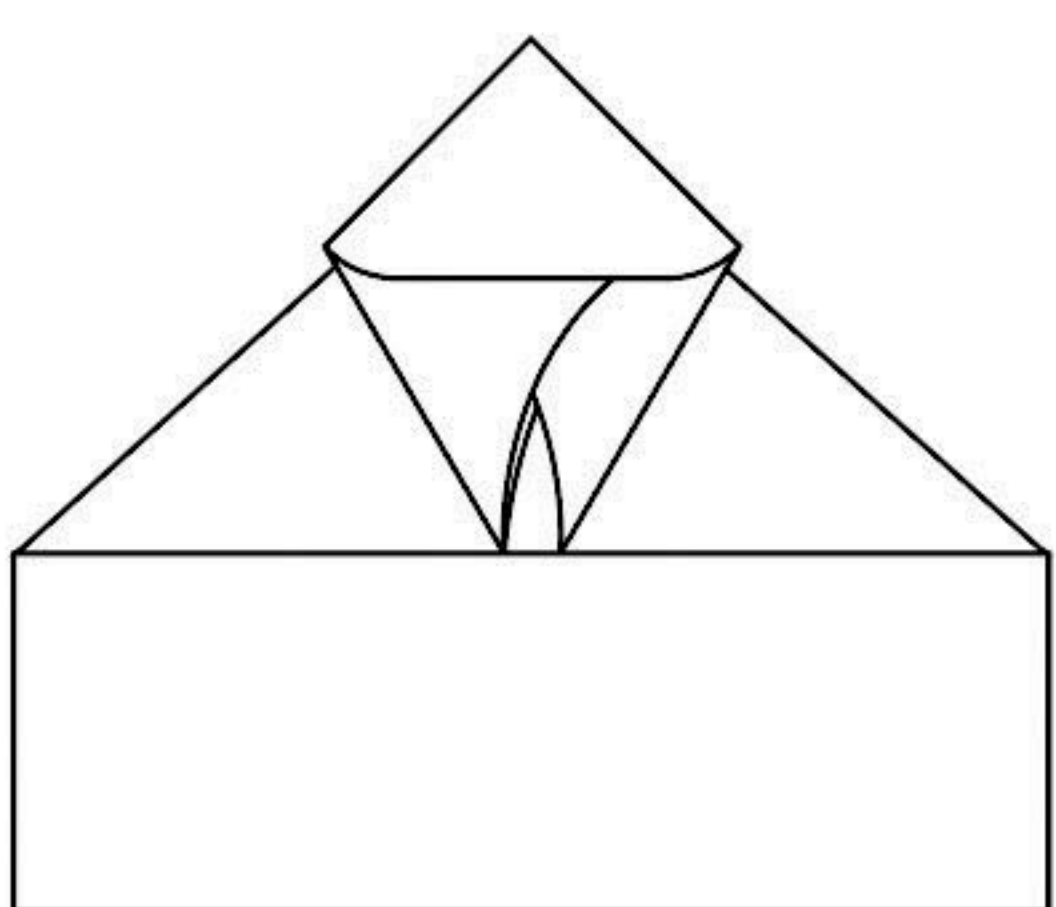
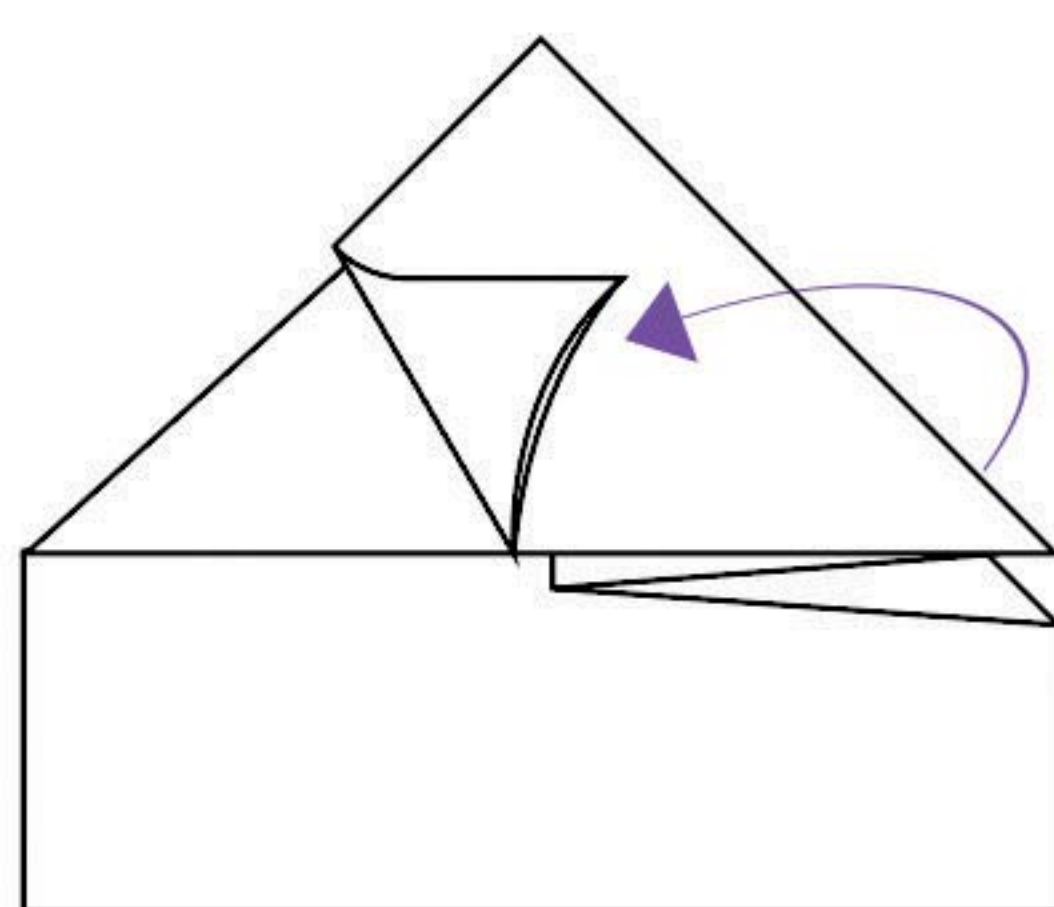

Step 5: Fold over the right flap and tuck it in the left flap to form the hoop.

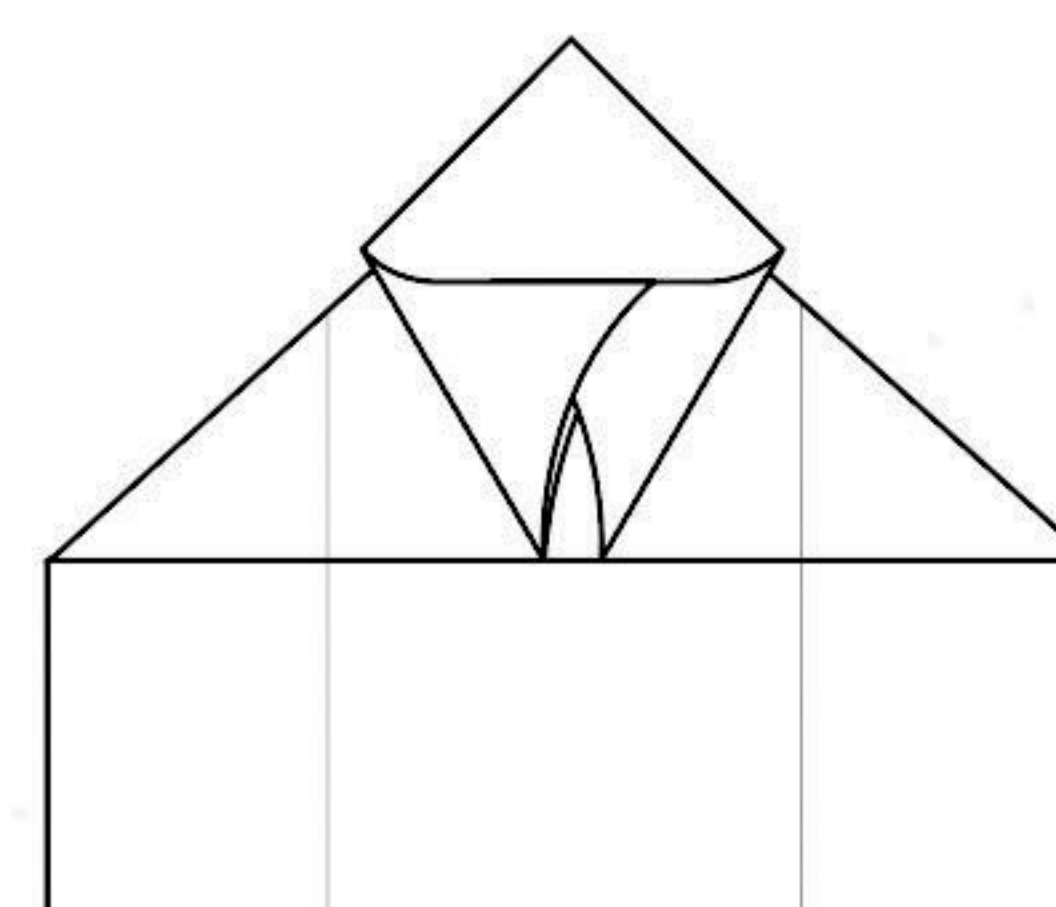
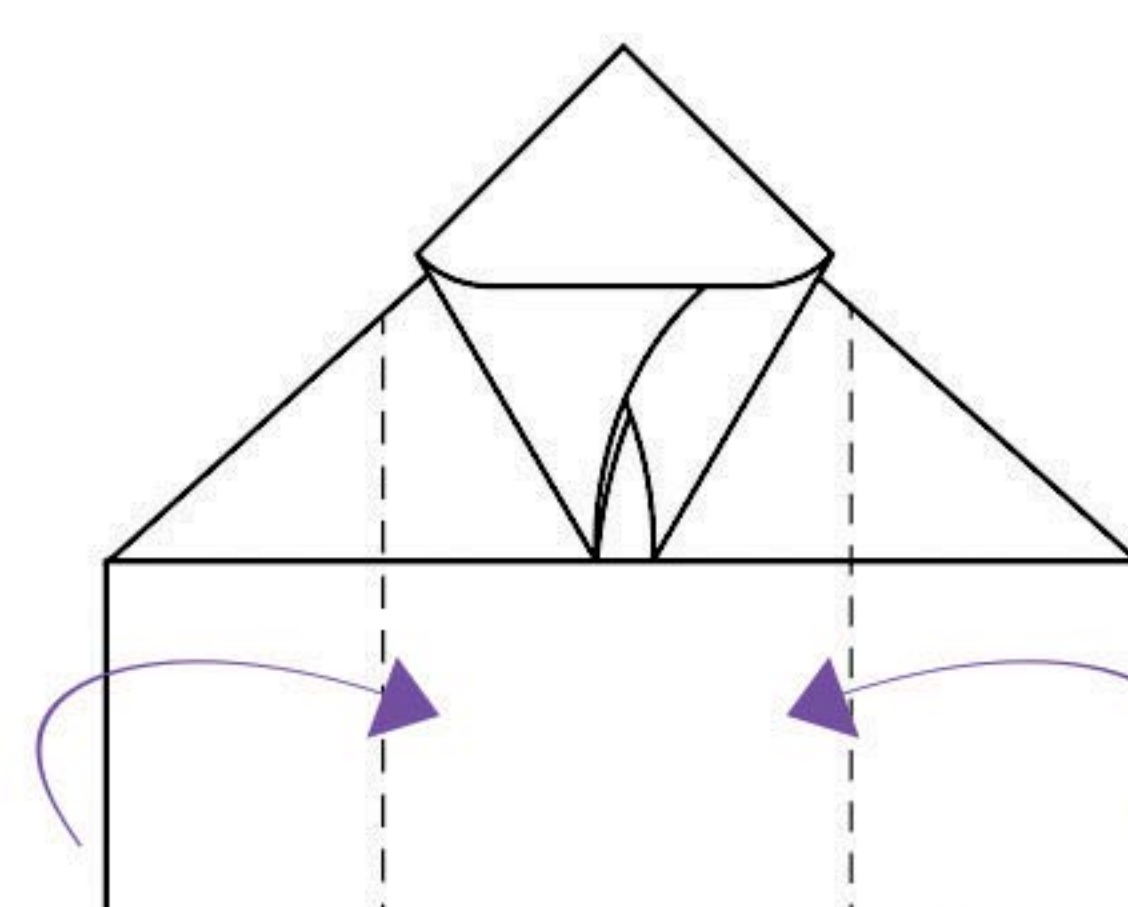

Step 6: Fold in sides so that the hoop stands.

Step 7: Color in your basketball hoop. Then make basketballs out of wads of paper and shoot away!

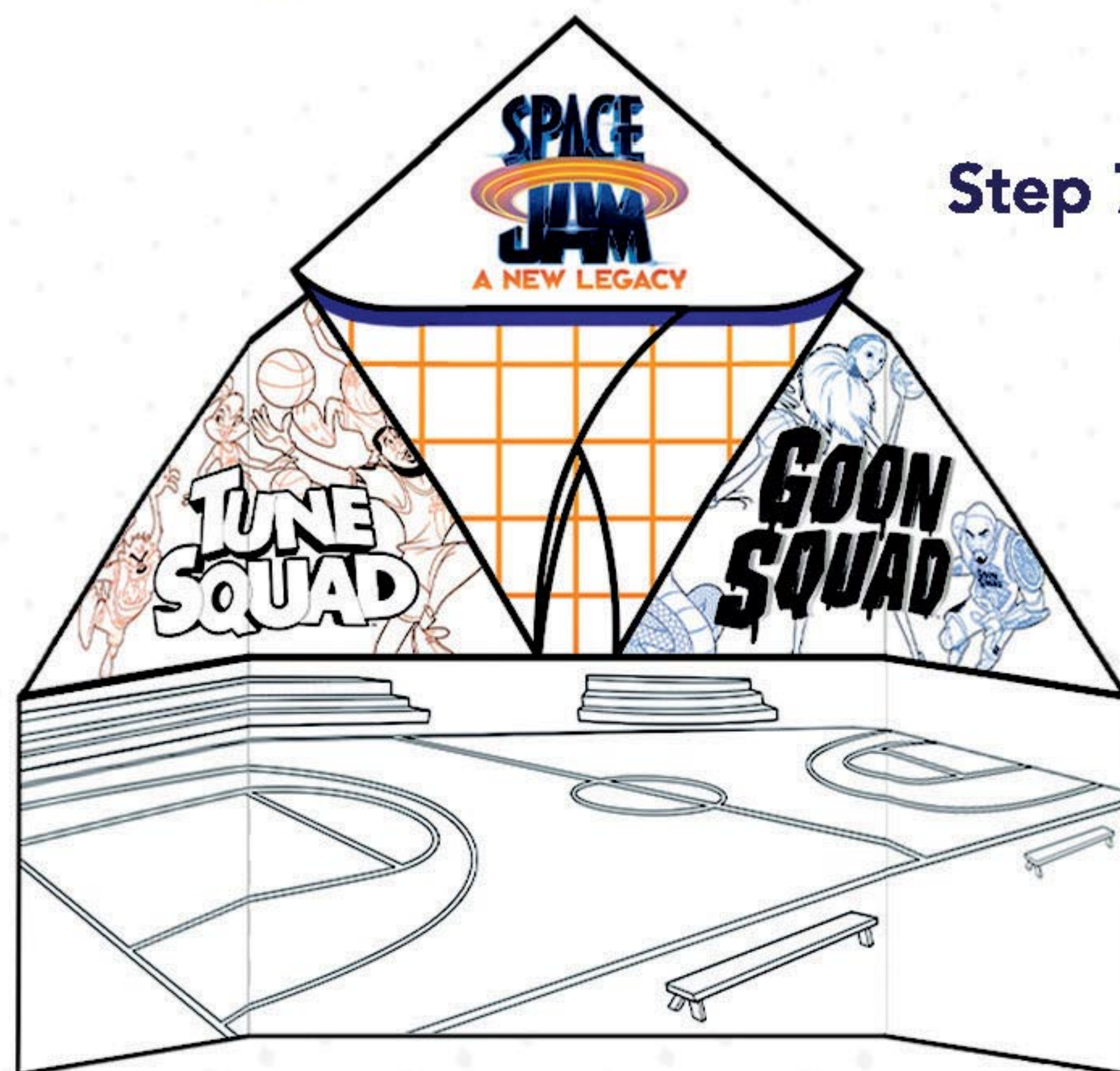

JULY 16

SEE IT
IN THEATERS

AND ON
HBOMAX
ONLY AVAILABLE ON THE AD-FREE PLAN

Color in both sides of the basketball origami hoop to set your own game atmosphere.

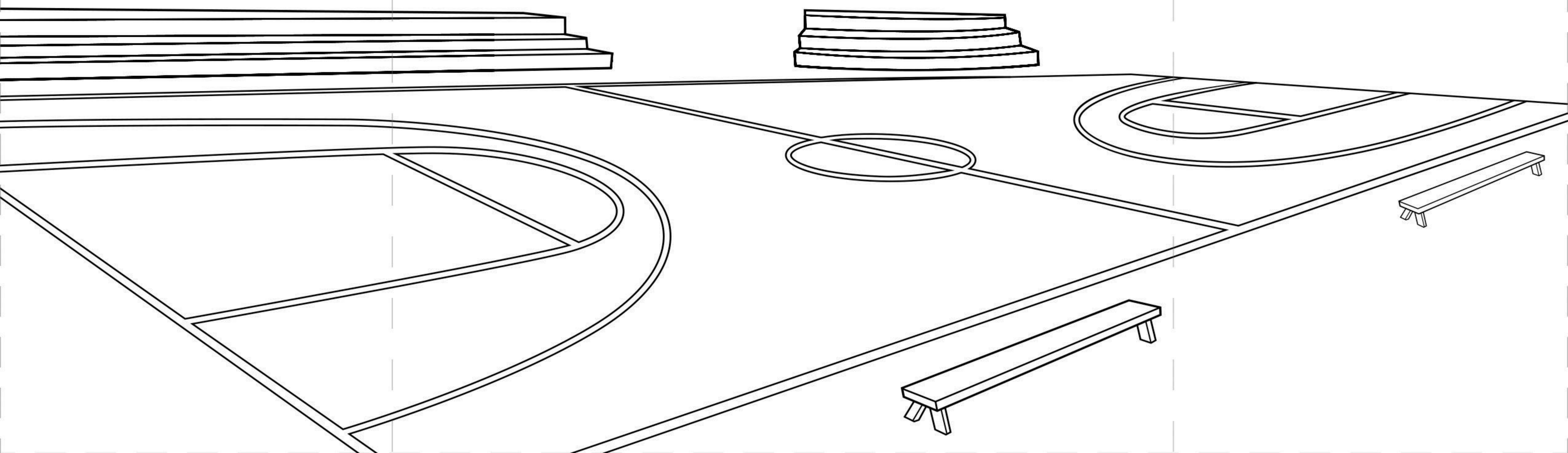

A NEW LEGACY



CUTOUT HEADBANDS

Instructions:

1. Cut out characters along dotted line.
2. Cut out headband pieces and glue together.
3. Glue or tape on desired character to headband.



**SPACE
JAM**
A NEW LEGACY

ATTACH
CHARACTER
CUTOUT HERE

GLUE TO LEFT
SIDE OF MAIN
HEADBAND PIECE

GLUE TO LEFT
SIDE OF MAIN
HEADBAND PIECE

CUTOUT HEADBANDS

Instructions:

1. Cut out characters along dotted line.
2. Cut out headband pieces and glue together.
3. Glue or tape on desired character to headband.

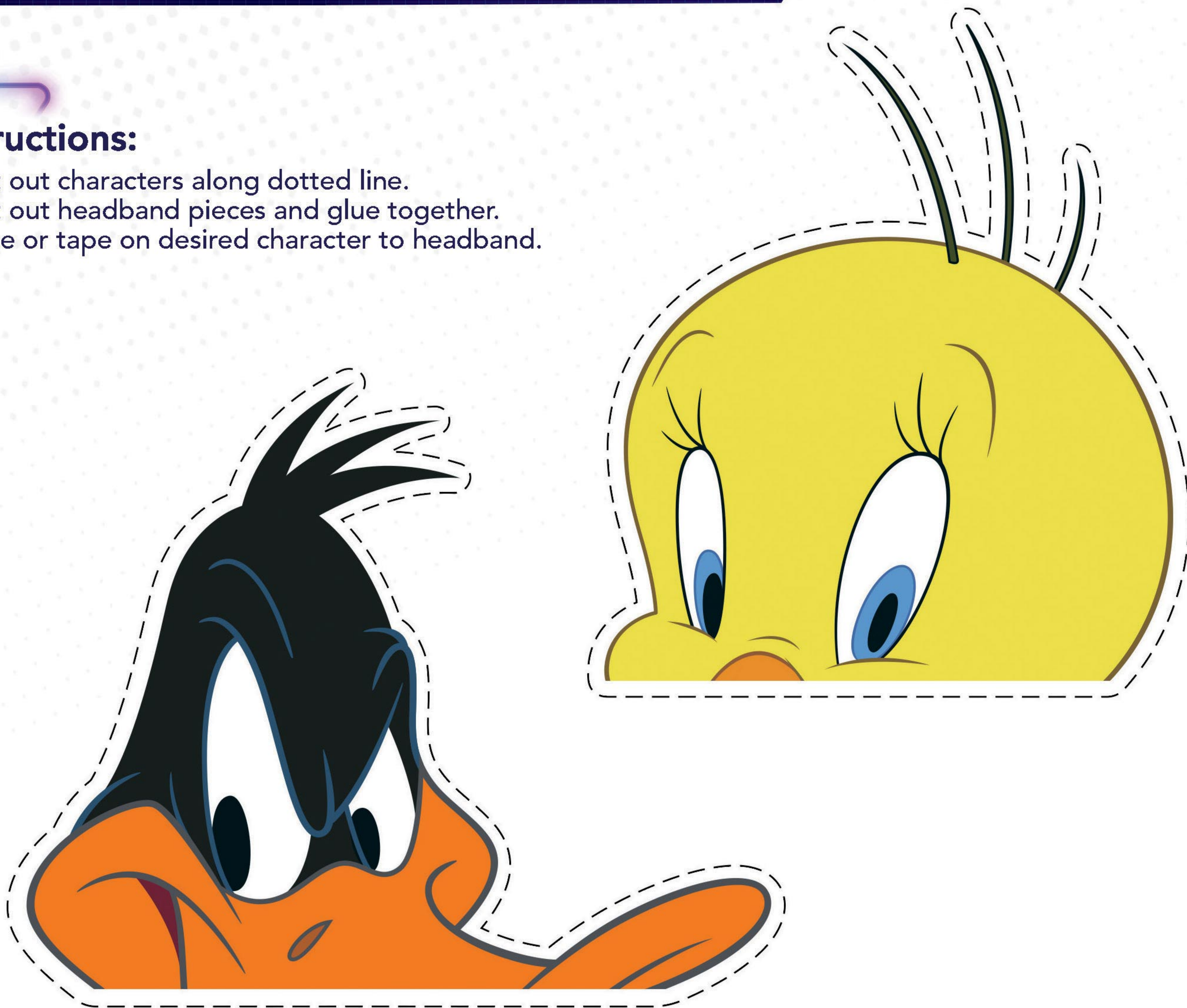

**SPACE
JAM**
A NEW LEGACY

ATTACH
CHARACTER
CUTOUT HERE

GLUE TO LEFT
SIDE OF MAIN
HEADBAND PIECE

GLUE TO LEFT
SIDE OF MAIN
HEADBAND PIECE



CUTOUT MASKS

Instructions:

1. Cut out along heavy outer line.
2. Cut out eyes and punch holes for string.
3. Tie mask on with string.

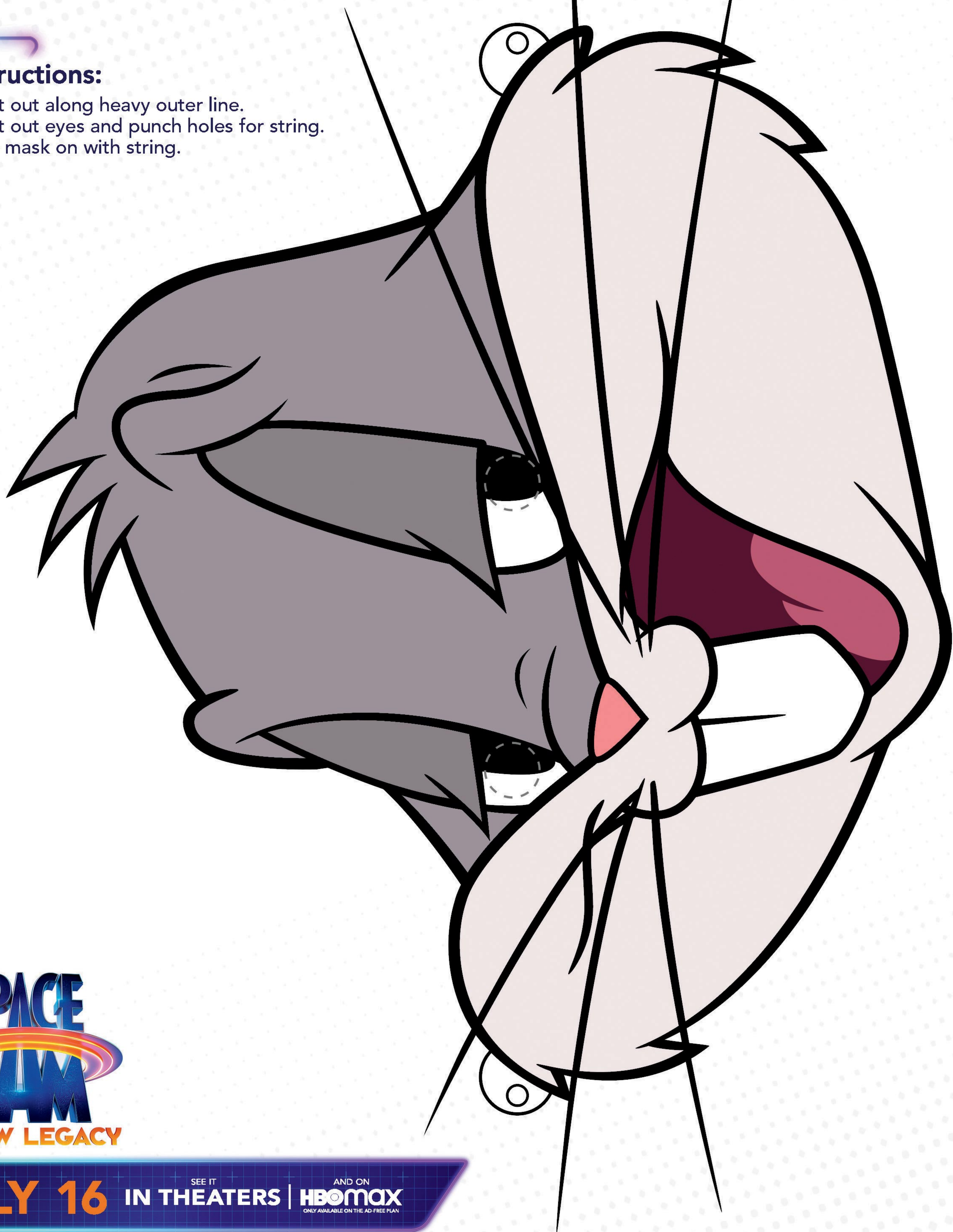

**SPACE
JAM**
A NEW LEGACY

JULY 16

SEE IT
IN THEATERS

AND ON
HBOMAX
ONLY AVAILABLE ON THE AD-FREE PLAN

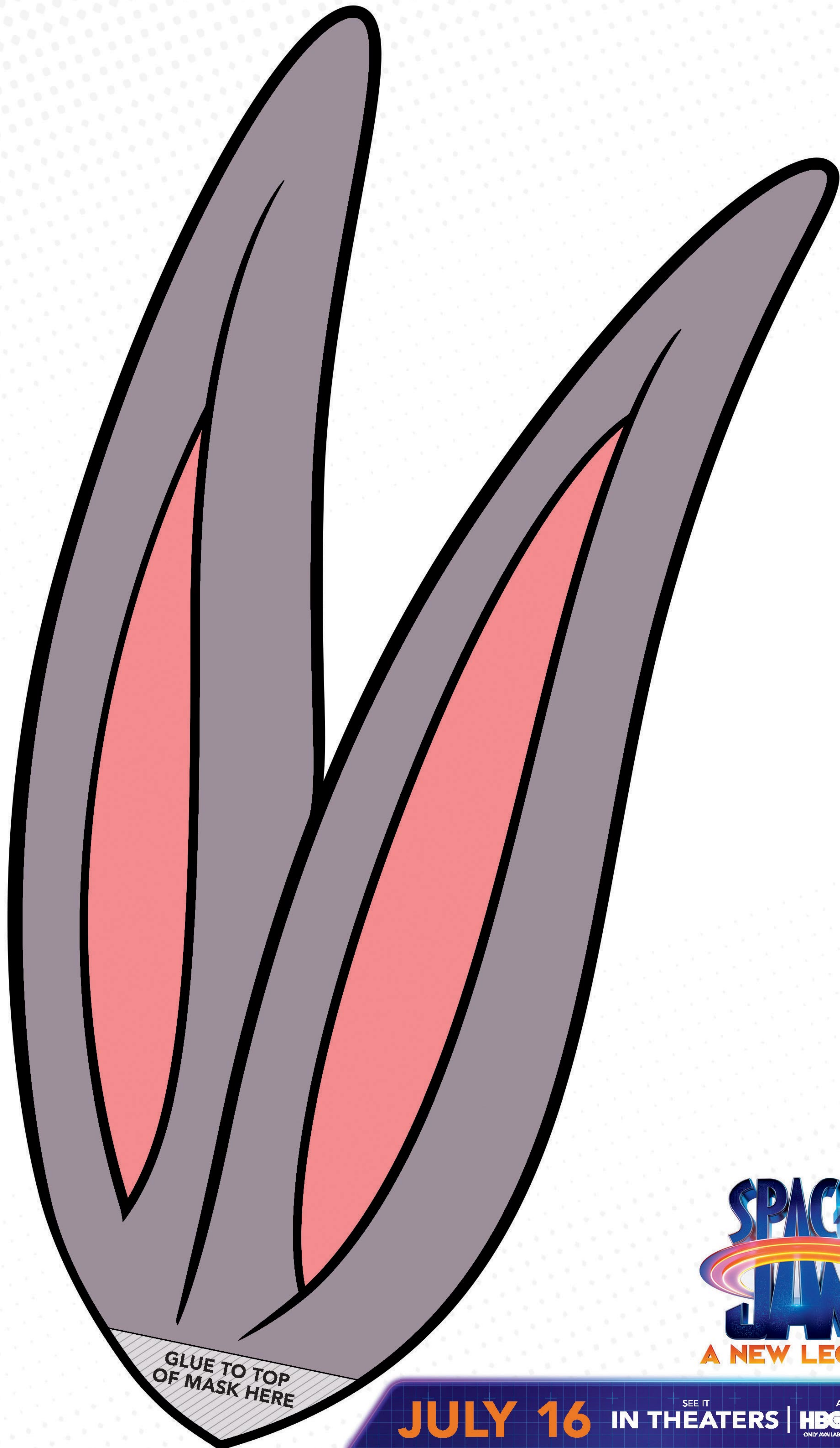

**SPACE
JAM**
A NEW LEGACY

JULY 16

SEE IT **IN THEATERS**

AND ON **HBOMAX**
ONLY AVAILABLE ON THE AD-FREE PLAN







**SPACE
JAM**
A NEW LEGACY

JULY 16

SEE IT
IN THEATERS

AND ON
HBOMAX
ONLY AVAILABLE ON THE AD-FREE PLAN

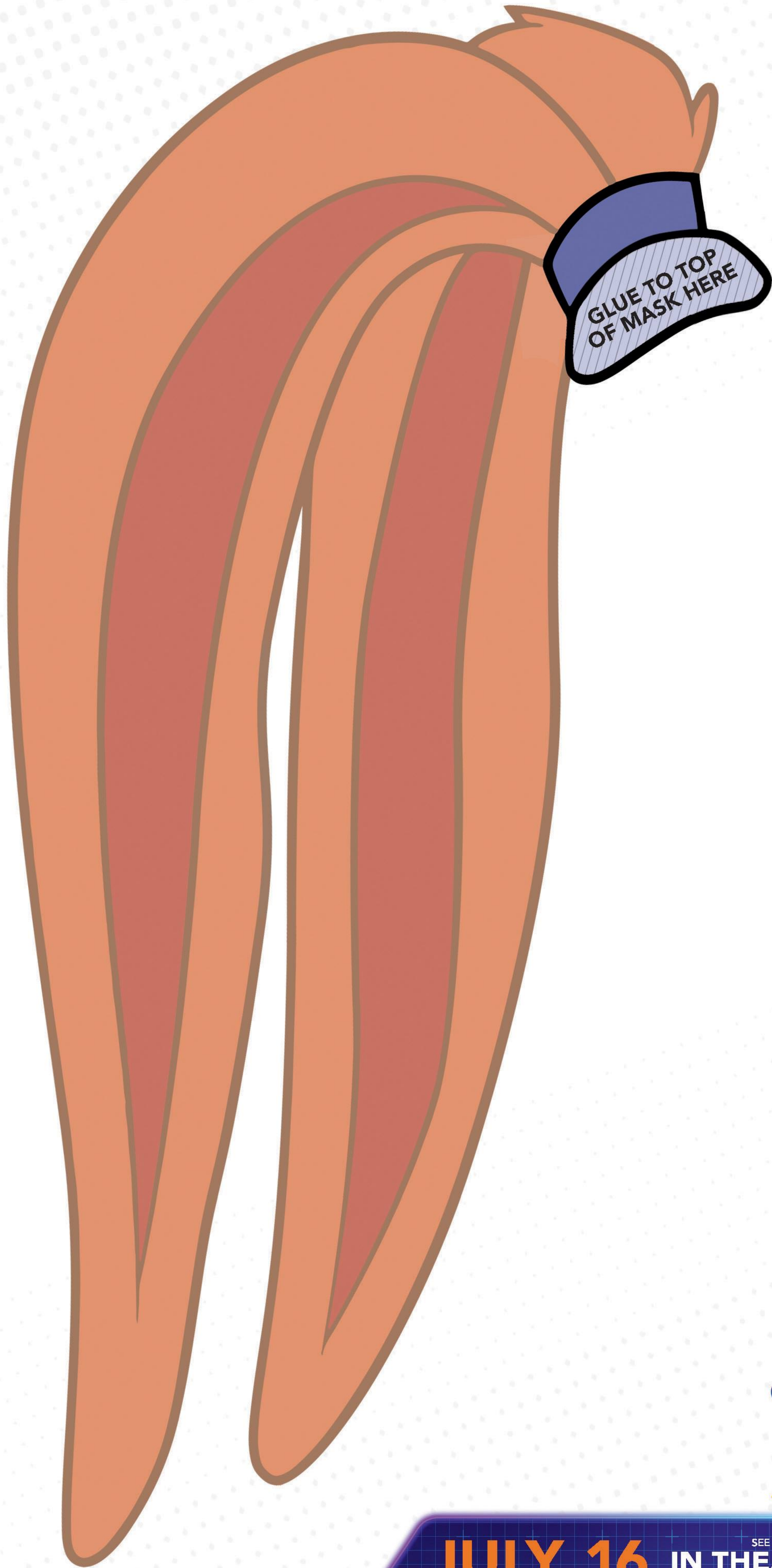

JULY 16 IN THEATERS | SEE IT AND ON **HBOMAX**
ONLY AVAILABLE ON THE AD-FREE PLAN







**SPACE
JAM**
A NEW LEGACY

JULY 16

SEE IT
IN THEATERS

AND ON
HBOMAX
ONLY AVAILABLE ON THE AD-FREE PLAN









**SPACE
JAM**
A NEW LEGACY

JULY 16

SEE IT
IN THEATERS

AND ON
HBOMAX
ONLY AVAILABLE ON THE AD-FREE PLAN

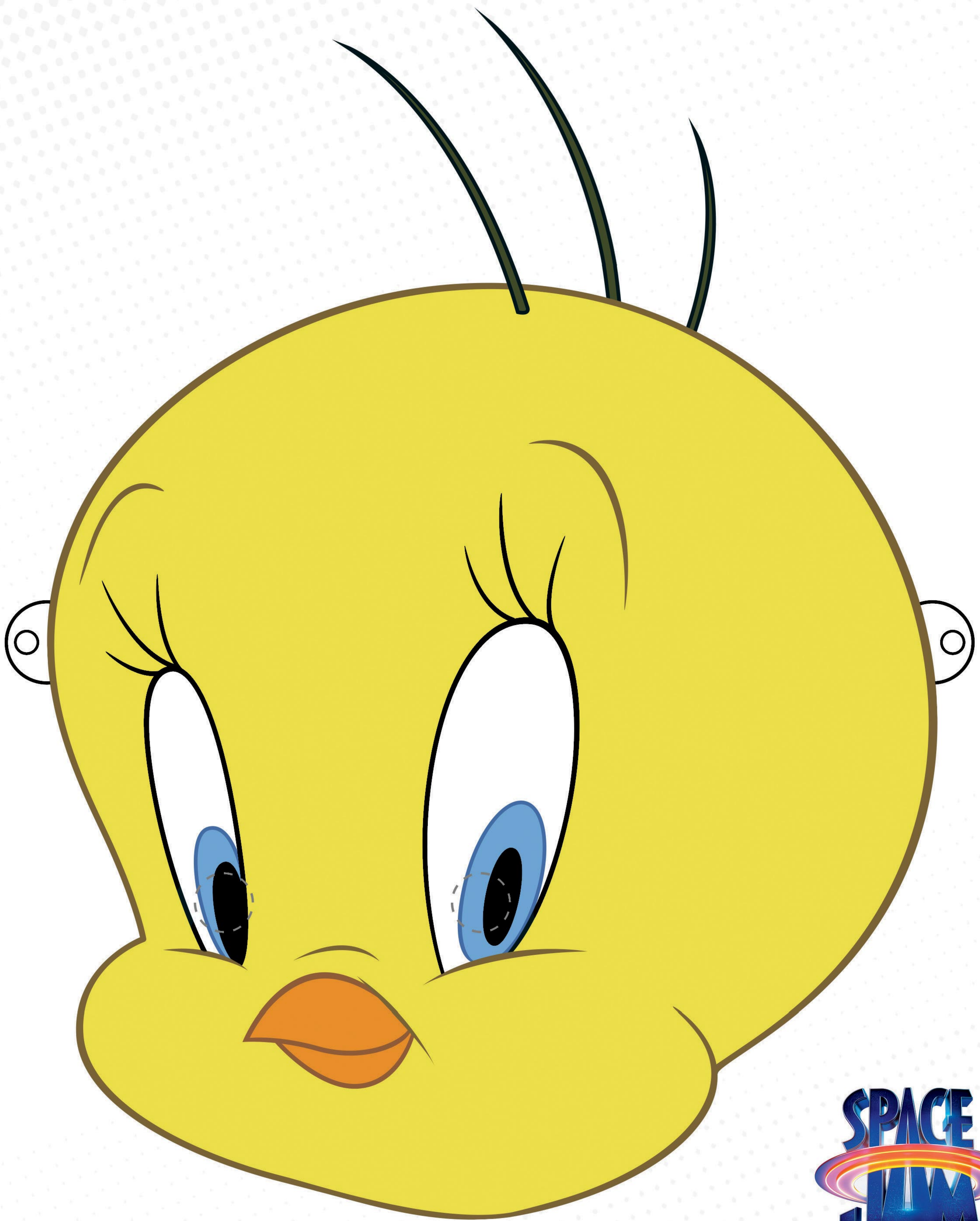

**SPACE
JAM**
A NEW LEGACY

JULY 16 SEE IT **IN THEATERS** | **AND ON** **HBOMAX**
ONLY AVAILABLE ON THE AD-FREE PLAN



DESIGN YOUR OWN TRADING CARD

GAME ANSWERS

WORD SCRAMBLE (Pg. 16)

1. Porky Pig
2. Tasmanian Devil
3. Bugs Bunny
4. Tweety
5. Daffy Duck
6. Road Runner
7. Elmer Fudd
8. Yosemite Sam
9. Sylvester
10. Lola Bunny
11. Foghorn Leghorn
12. Speedy Gonzales
13. Granny
14. Wile E Coyote
15. Gossamer

WORD SEARCH (Pg. 17)

I L A F N A M R E P U S T A J E A F N O D W K
 S J E M U V D U D K H A H L A X F W N R B B
 E G E G Y A T X A M D A M F O I S E A V L A
 N O V C A X W I T T W G F A J M A C T M A H S
 O E W M L W W S B W I E I A A F T A A K
 R O O N W W H O P T P E R N I D Y T A J R E
 H S D G O A N Y Q I T E Q U N O U B V R T
 T E K R C T D A Y P N N T A V T C E Z Y B
 F M W O H N E E D I H Y P E Y D K E M E X P A
 O A O N T A M R V H O Y Y O B U P I T R L O L
 E J G S A A V T D A I A R W R C I G O I T
 M G P K B M O X H M G V O I E Q K N M I T M
 A N D V Y A B M D A H K N L Q E R W O N G F
 G I N V N S A A I R O N G I A N T E D H E R S
 H K V S A A N X B K R Y C H R O N O G O R H
 R M G N A C O N Y N N U B E C U B R W A Y A T

SECRET CODE REVEAL (Pg. 19)

1. What's up doc?
2. You're despicable!
3. Sufferin' Succotash!
4. That's all folks!

FIND THE DIFFERENCE (Pg. 20)



PLAY BALL MAZE (Pg. 22)

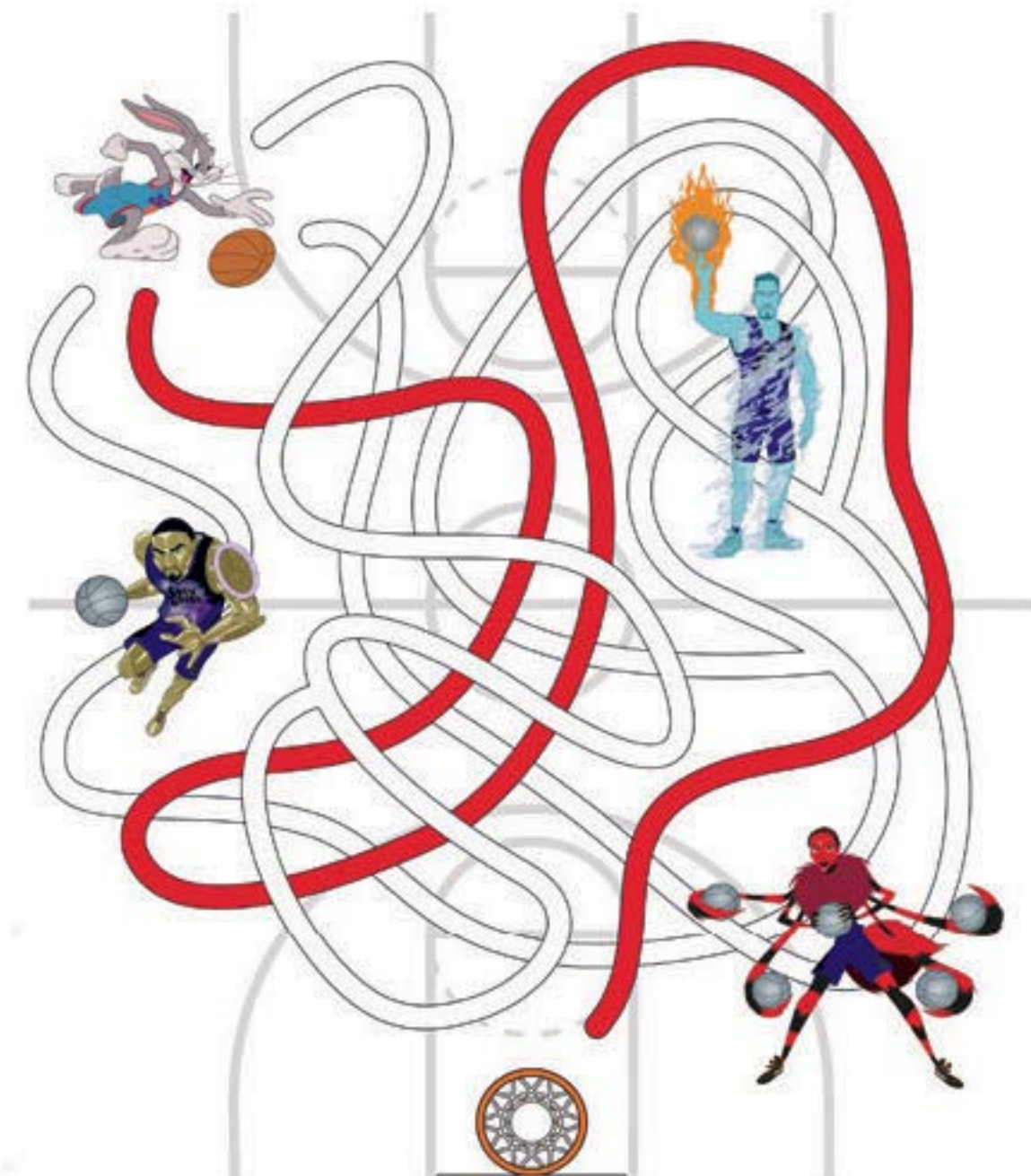

CROSSWORD PUZZLE (Pg. 23)

1. Lola Bunny
2. Dribble
3. Wile E Coyote
4. Cartoon
5. Tasmanian Devil
6. Foghorn Leghorn
7. Speedy Gonzales
8. Across: Sylvester
8. Down: Space Jam
9. Granny
10. Yosemite Sam
11. Elmer Fudd
12. Tune Squad
13. Goon Squad
14. Slam Dunk
15. Fun

SPACE JAM: A NEW LEGACY
TRADING CARDS

Follow the dotted lines and cut out the collectible Tune Squad and Goon Squad double-sided trading cards.

GRANNY

88

TEAM:

TUNE SQUAD

ANIMAL:
HUMAN (OLD)

HEIGHT:
4'3"

FAVORITE FOOD:
APPLESAUCE

FAVORITE SAYING:
"I'M GOING OLD SCHOOL ON HIS BUTT"



PORKY PIG

8

TEAM:

TUNE SQUAD

ANIMAL:
PIG

HEIGHT:
3'2"

FAVORITE FOOD:
ANYTHING BUT BACON

FAVORITE SAYING:
"THAT'S ALL FOLKS"



GOSSAMER

00

TEAM:

TUNE SQUAD

ANIMAL:
MONSTER

HEIGHT:
6'

FAVORITE FOOD:
WITCH'S BREW

FAVORITE SAYING:
NON-VERBAL



WILE E. COYOTE

13

TEAM:

TUNE SQUAD

ANIMAL:
COYOTE

HEIGHT:
4'3"

FAVORITE FOOD:
ROADRUNNER

FAVORITE SAYING:
"HELP"



YOSEMITE SAM

22

TEAM:

TUNE SQUAD

ANIMAL:
HUMAN

HEIGHT:
2'6"

FAVORITE FOOD:
BEANS

FAVORITE SAYING:
"VARMINT!"



FOGHORN LEGHORN

33

TEAM:

TUNE SQUAD

ANIMAL:
ROOSTER

HEIGHT:
5'5"

FAVORITE FOOD:
POULTRY FEED

FAVORITE SAYING:
"I SAY, I SAY, I SAY"



ELMER FUDD

53

TEAM:

TUNE SQUAD

ANIMAL:
HUMAN

HEIGHT:
3'8"

FAVORITE FOOD:
RABBIT

FAVORITE SAYING:
"SHHH. BE VEVY VEVY QUIET, I'M HUNTING WABBITS"



GOON SQUAD

WHO IS THE GOON SQUAD?

DAMIAN LILLARD AS CHRONOS
FAVORITE SAYING:
"IT'S THE KING STOPPER!"

NNEKA OGWUMIKE AS ARACHNNEKA
FAVORITE SAYING:
"QUEEN OF THE WEB"

KLAY THOMPSON AS WET/FIRE
FAVORITE SAYING:
"WET BALL BABY"

DIANA TAURASI AS WHITE MAMBA
FAVORITE SAYING:
"WHASSSTTHHH UP"

ANTHONY DAVIS AS THE BROW
FAVORITE SAYING:
"FLYEST GUY ON THE SQUAD"



**PORKY
PIG**



**SPACE
JAM**
A NEW LEGACY

GRANNY



**SPACE
JAM**
A NEW LEGACY

**YOSEMITE
SAM**



**SPACE
JAM**
A NEW LEGACY

**WILE E.
COYOTE**



**SPACE
JAM**
A NEW LEGACY

GOSSAMER



**SPACE
JAM**
A NEW LEGACY

**GOON
SQUAD**



**SPACE
JAM**
A NEW LEGACY

**ELMER
FUDD**



**SPACE
JAM**
A NEW LEGACY

**FOGHORN
LEGHORN**



**SPACE
JAM**
A NEW LEGACY

LOLA BUNNY

TEAM:

TUNE SQUAD

ANIMAL:
RABBIT

HEIGHT:
3'5" (4' WITH HER EARS)

FAVORITE FOOD:
PROTEIN SHAKE

FAVORITE SAYING:
"GOT YOU 'BRON"

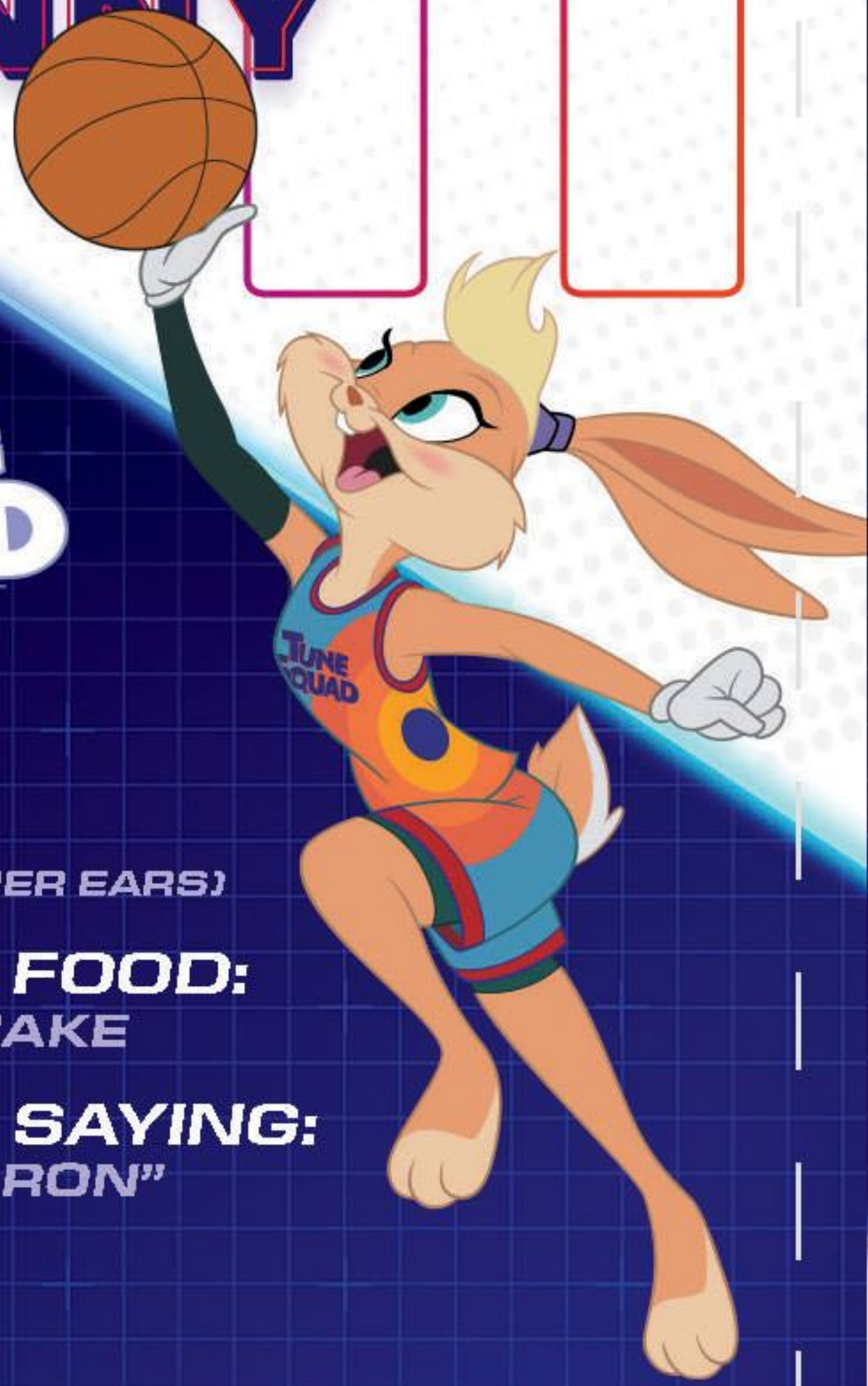

LEBRON JAMES

TEAM:

TUNE SQUAD

ANIMAL:
HUMAN

HEIGHT:
6'8.5"

FAVORITE FOOD:
TACOS

FAVORITE SAYING:
"TO BE GREAT, YOU HAVE TO PUT IN THE WORK"



BUGS BUNNY

TEAM:

TUNE SQUAD

ANIMAL:
RABBIT

HEIGHT:
3'5" (4' WITH HIS EARS)

FAVORITE FOOD:
CARROTS

FAVORITE SAYING:
"WHAT'S UP DOC?"



DAFFY DUCK

TEAM:

TUNE SQUAD

ANIMAL:
DUCK

HEIGHT:
3'4"

FAVORITE FOOD:
SPAGHETTI & MEATBALLS

FAVORITE SAYING:
"YOU'RE DETH-PICABLE!"



COACH

TWEETY BIRD

TEAM:

TUNE SQUAD

ANIMAL:
BIRD

HEIGHT:
8"

FAVORITE FOOD:
SEEDS

FAVORITE SAYING:
"I TAWT I TAW A PUDDY CAT"



1/3

TAZ

TEAM:

TUNE SQUAD

ANIMAL:
TASMANIAN DEVIL

HEIGHT:
2'6"

FAVORITE FOOD:
WHATEVER IS IN HIS PATH!

FAVORITE SAYING:
"ARGHRGHRGHRGHRGH"



SYLVESTER

TEAM:

TUNE SQUAD

ANIMAL:
CAT

HEIGHT:
3'

FAVORITE FOOD:
BIRDS (OF THE YELLOW VARIETY)

FAVORITE SAYING:
"SUFFERIN' SUCCOTASH"

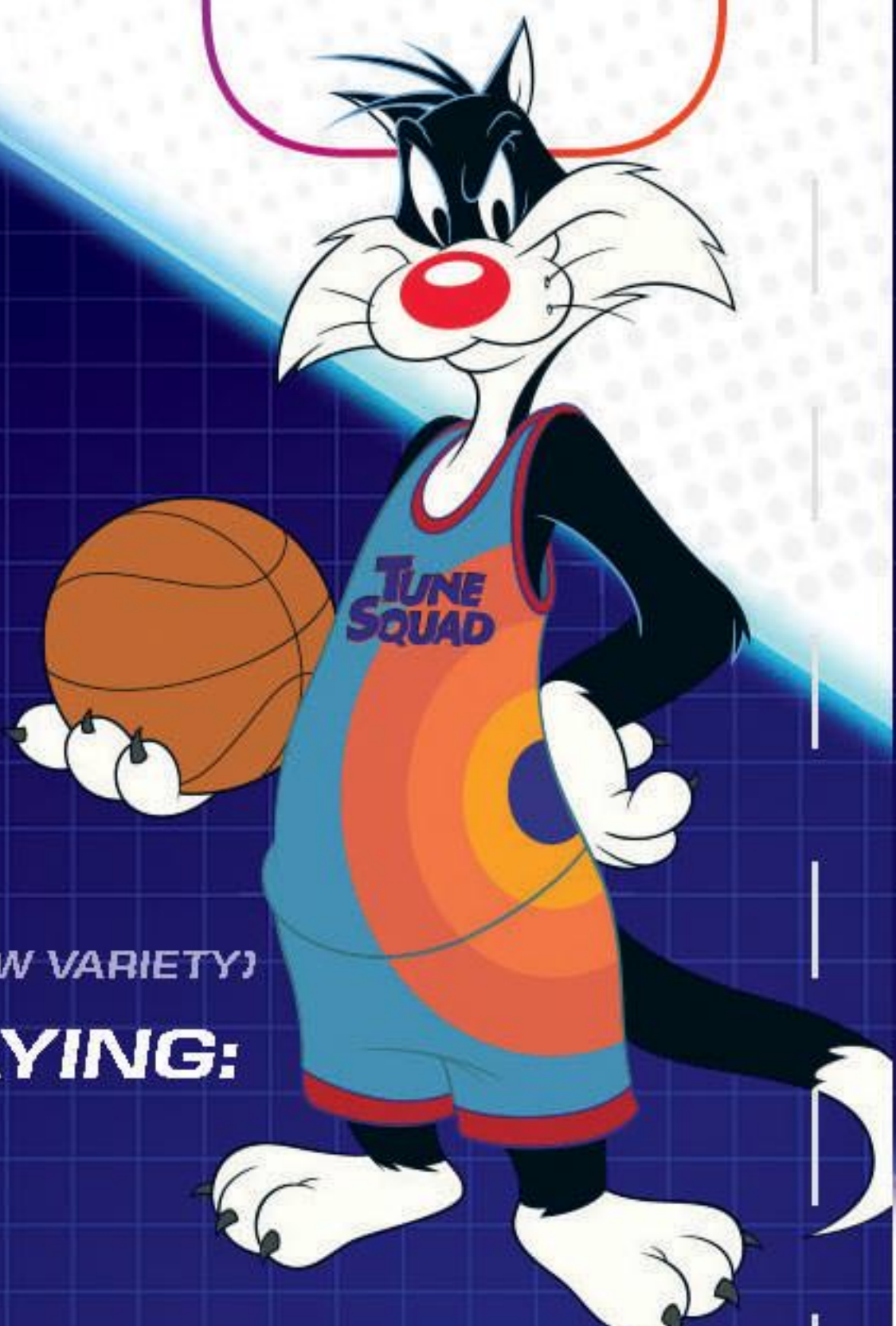

SPEEDY GONZALES

TEAM:

TUNE SQUAD

ANIMAL:
MOUSE

HEIGHT:
6"

FAVORITE FOOD:
CHEESE

FAVORITE SAYING:
"ARRIBA ARRIBA!"



ROAD RUNNER

TEAM:

TUNE SQUAD

ANIMAL:
ROAD RUNNER

HEIGHT:
2'9"

FAVORITE FOOD:
PILE OF SEEDS

FAVORITE SAYING:
"BEEP BEEP"



**BUGS
BUNNY**



**SPACE
JAM**
A NEW LEGACY

**LEBRON
JAMES**



**SPACE
JAM**
A NEW LEGACY

**LOLA
BUNNY**



**SPACE
JAM**
A NEW LEGACY

TAZ



**SPACE
JAM**
A NEW LEGACY

**TWEETY
BIRD**



**SPACE
JAM**
A NEW LEGACY

**DAFFY
DUCK
COACH**



**SPACE
JAM**
A NEW LEGACY

**ROAD
RUNNER**



**SPACE
JAM**
A NEW LEGACY

**SPEEDY
GONZALES**



**SPACE
JAM**
A NEW LEGACY

SYLVESTER



**SPACE
JAM**
A NEW LEGACY



A NEW LEGACY

 WARNER ANIMATION GROUP

Soundtrack available on Republic Records
Score Album on WaterTower Music

©2021 WarnerMedia Direct, LLC.
All Rights Reserved.
HBO Max™ is used under license.

 WARNER BROS.
PICTURES

AVAILABLE ON HBO MAX FOR 31 DAYS FROM THEATRICAL RELEASE